



RENEWABLE
ENERGY

—
2023



WIND TURBINE SIMULATOR - NETWORK INJECTION

EOLYP is a test bench dealing with the study of the hyper synchronous activity of a wind turbine for its electricity production aspects, excluding the mechanical aspects. Due to noise pollution and draughts, which are incompatible with a classroom environment, the propeller has been replaced by a variable speed drive motor.

The functional diagram presents the operating principle. The safety components placed in the electrical cabinet are not represented to simplify reading. The propeller, for which the operator adjusts the speed, drives the generator from 0 to 1800 rpm. Two sensors placed on the shaft, returns rotation speed and torque information to the console which displays this information. The generator is coupled to the public three-phase network, through an electrical measurement bench indicating the:

- active power injected into the network.
- voltage between phases
- current
- power factor.

The central-zero wattmeter shows that depending on the drive speed, the generator consumes or produces energy highlighting the hypersynchronous and hyposynchronous operations. The voltage/current distortion also changes with the rotation speed as indicated by the central-zero power factor meter. The adjustable capacitors battery is used to adjust the power factor to around 1 depending on the speed and power produced.

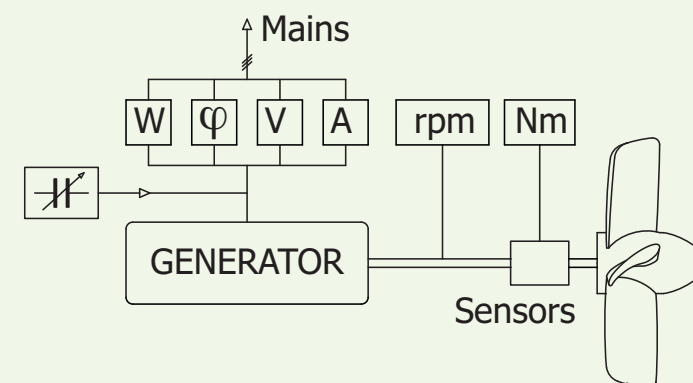

ref. EOLYP

ref. EOLYP-ECO without sensor and display unit

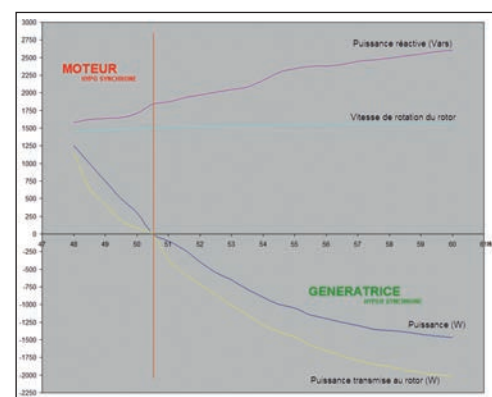

EDUCATIONAL OBJECTIVES

- Understanding the mechanical & electrical principles of a wind turbine.
- Studying the hypo-synchronous and hyper-synchronous operating modes of an asynchronous motor.
- Studying the synchronization of the electrical network.
- Calculating the efficiency of the energy production system.
- Using a clamp-on Ammeter.

TEACHING RESOURCES STUDENT & TEACHER

Proposed Practical Works

- Reminders on the wind turbine functioning.
- Synchronization procedure on the electrical network.
- Raising the power factor by a capacitors bank and study the results.
- Plotting the electrical characteristics of the energy production system.
- Calculating the overall efficiency.
- Studying of the functioning in an isolated site.

COMPRISES

- 1 frame on casters, dim. 1200x750mm height : 1820mm. Weight: 143kg.
- 1 asynchronous motor 1.5 kVA
- 1 generator
- 1 DC tachogenerator / 1 torque sensor
- 1 command console
- 1 electrical cabinet
- 1 network coupling unit

GENERATOR FEATURES

- Generator: 3 x 400VAC Asynchronous motor.
- Active power injected into the network: 0 to 1.2kVA
- Generator efficiency: 78%
- Speed variation: 0 to 1800 rpm

ELECTRICAL CABINET FEATURES

- Inside**
- 30 mA circuit breakers & thermal-magnetic and thermal circuit breakers.
 - 2.2kVA speed controller with control unit on the console.
 - stepped capacitors battery

On the front

- 1 emergency stop circuit breaker
- 1 switch disconnecter
- 1 stop/Start button with push button
- 4 switches triggering the capacitors to rectify the cosφ
- 2 indicator lights show a thermal fault on the motor and generator



ACQUISITION PACK



ref. EOL-COM2

EOL-COM2 is an option for EOLYP and EOLYP-ECO. This option allows recording and plotting on PC the electrical values as voltage, current and power provided to the Electrical network. The software supplied displays these electrical values in real time and collects them in Excel format.



During the acquisition, the values of U/I/P are displayed at the same time as curves and numerical values. Connection on PC by a USB cable of 2m (supplied). Mains supply: 230Vac - 50/60Hz

DISPLAY

By two displays 2000 pts and one display 2000 pts with LEDs.

INPUTS

Voltage inputs: Three floating potential voltage terminals, situated at the rear of the apparatus allowing either the application of an alternating, continuous or composite voltage, or a balanced three phase voltage. These inputs are electronically protected against over voltages. Max. voltage: 400Vrms single phase, 700Vrms three phase

Current inputs: Two floating potential current terminals, situated at the rear of the apparatus allowing the application of an alternating, continuous or composite current. I_{max} = 20A. The current input is protected by a delay fuse, allowing measurements on starting up a motor

RECOPY OUTPUTS

Voltage output: 0 to 10V DC signal for 0 to 1000Vrms entering.
Current output: 0 to 10V DC signal for 0 to 20Arms entering.
Power output: 0 to 10V DC for 0 to 0.2kW - 0 to 2kW - 0 to 20kW; these three ratings are switched automatically.
Important: these three outputs are insulated from the voltage and currents applied to the input terminals of the apparatus.

OTHER CHARACTERISTICS

Dimensions of each case : 375 x 80 x 275mm. Weight : 5kg.

Function	U	I	W
Ranges	400Vrms single-phase 700Vrms 3-phase	20Arms	0.2 - 2 - 20kW
Accuracy			
in %	1% from 0 to 70kHz	2% 0 ~ 20kHz 3% 20 ~ 70kHz	2% 0 ~ 20kHz 3% 20 ~ 30kHz 5% 30 ~ 70kHz
Protection	Electronic breaker	20A delayed fuse	
Impedance	1.5MΩ	<5mΩ	
Recopy outputs	10VDC/1000Vrms	10VDC/20Arms	10VDC/ 0,2kW - 2kW - 20kW

THREE-PHASE WIND TURBINE 400W



EOLYS-500 is a three-phase wind turbine 400W belt-linked to a driven motor that simulates the wind strength. This system is suited to class room conditions. It perfectly simulates wind turbine operation without noise or draughts since there is no fan. Protected by a transparent cover, the wind turbine can be seen with no risk of direct contact. EOLYS-500 is more than a simulator because it rotates a true three-phase generator and short blades.

EDUCATIONAL OBJECTIVES

- Understanding the different elements of a wind turbine.
- Make the measurements of electrical parameters (3-phase and continuous).
- Analyzing and interpreting results.
- Studying the efficiency and impacts related to the wind force.
- Studying the chain of wind energy (production, storage, consumption, energetic behavior).
- Control and set a speed variator from a PC.

DELIVERED WITH TESTS & PRACTICAL WORKS



ref. EOLYS-500

Wind turbine features

- Three-phase output 3 x 53V AC - 400W at 370 rpm on safety terminals.
- Direct current output 90V DC - 400W at 370 rpm on safety terminals.
- Selection of these outputs by using an included rectifier or by direct connection.

Features of the wind simulation

- Squirrel-cage three-phase asynchronous motor.
- Speed controller simulating wind turbine speed 0-400 rpm.
- Using the supplied SOMOVE software, the PC operations are:
 - Acceleration of the wind speed.
 - Deceleration of the wind speed.

General features

- Wheeled frame with brakes
- Overall dimensions: 750 x 670 x (h) 1500 mm
- Top cover made with aluminium frame and Lexan sides (translucent and unbreakable).
- Power supply 2P+N+E 230V AC - 50/60 Hz (5m lead with mains plug)
- Supplied with: Practical assignments in the form of measurements/tests; RJ45-USB cable for linking between the speed controller and the PC. **Schneider® SoMove software.**

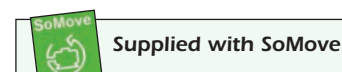

DC output
AC output

EXAMPLE OF COMPATIBLE LOAD

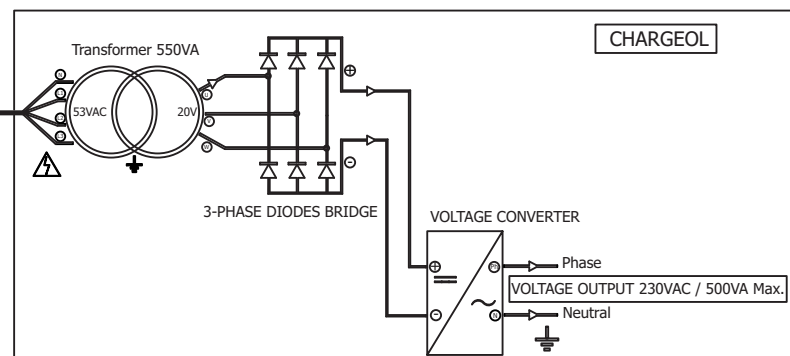
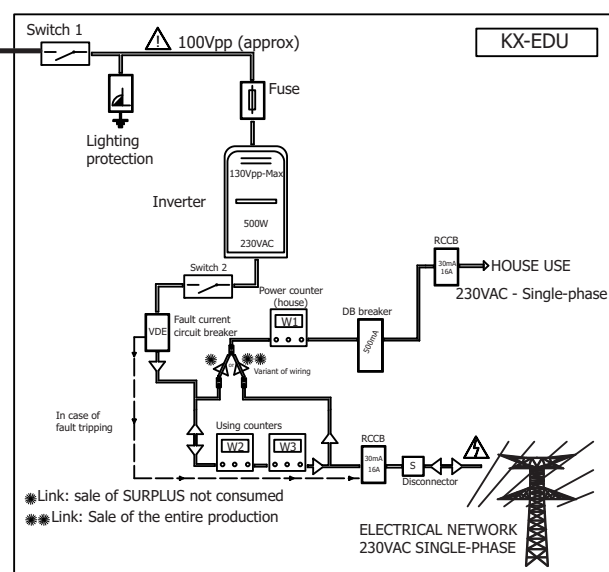

THREE-PHASE WIND TURBINE UNITS 400W

EDUCATIONAL OBJECTIVES

- Understanding the different parts of a wind turbine.
- Make the measurements of electrical parameters.
- Analyzing and interpreting results.
- Studying the efficiency and impacts related to the wind force.
- Study the chain of wind energy (production, storage, consumption, energetic behavior).
- Wiring of a wind turbine installation.
- Set up a Bluetooth connection

TEACHING RESOURCES STUDENT & TEACHER

Proposed practical works

- Studying and reading of the electrical features of the wind turbine.
- Calculate the system's efficiency.
- Realization of the diagram and wiring for the energy injection on the electrical network.
- Realization of a diagram & wiring for the energy use in an isolated site.
- Download and setup of the Bluetooth application

1. WIND TURBINE 400W

- SEE opposite EOLYS-500

2. ELECTRICAL CABINET

Standard technical cabinet on wheeled frame.
Dimensions: 810 x 600 x 1890mm base included.

Comprises

- 2 disconnectors
- 1 500mA -30A RC device
- 1 30mA RC device
- 1 lightning arrester + fuses
- 3 100Wh resolution meters
- 1 Mushroom head emergency stop
- 1 source inverter
- 1 charging controle. **Bluetooth®** 12/24VDC-20A
- 2 batteries 12V-12Ah
- 1 set of photovoltaic connectors
- 1 500W inverter for network synchronisation
- 1 Voltage converter 24VDC/230VAC-200W



Requires download in Play Store or Apple Store the free application "Victron Energy".

Display on tablet or Smartphone:

- Voltage - Current of the panel / Power (W)
- Voltage - Current of the battery / Charge current
- On-Off state charge



Smartphone not supplied



Reference EOL-1

Each reference includes:

1 turbine (Ref. EOLYS-500) + 1 specific electrical cabinet + 1 link cable

Ref	Communicating version	Features
EOL1	YES (Bluetooth®)	Operation with partial and total resale + at isolated site
EOL2	No	Partial or total resale operation only
EOL3	YES (Bluetooth®)	Operation at isolated site only

PARTIAL OR TOTAL RESALE OPERATION

In the cabinet, a DC/AC inverter converts the DC current from the turbine into alternating current 220VAC 50Hz and feeds it into the grid in synchronism. This inverter is protected against any polarity reversal and any overload on the DC or AC side. When the wind turbine is stopped, the inverter does not consume any power.

When the turbine is stopped, the inverter consumes no current

INVERTER	VOLTAGE	Max current	Power
INPUT	65~125VDC	8A	
OUTPUT	230VAC-50Hz	2,25A	400W

OPERATION AT ISOLATED SITE

The turbine current charges two 12V sealed batteries cabled in series through a charging controller. This DC voltage is either available on safety terminals at the rear of the cabinet, or transformed into 250VAC 50Hz voltage by a 300VA voltage converter.

Technical characteristics for the isolated site converter

VOLTAGE CONVERTER	Voltage	Max Current	Power
INPUT	20~32 VDC	11A	
OUTPUT	230VAC 50Hz	1.5A	300VA

STUDYING THE CONVERSION OF RENEWABLE ENERGY



ref. CONVERTYS
ref. CHARGEOL

EDUCATIONAL OBJECTIVES

- Study of the conversion of the electrical energy from 3-phase to single-phase.
- Make some measurements with a clamp-on ammeter.

TEACHING RESOURCES STUDENT & TEACHER

Proposed Practical Works

- Understanding of the wiring diagram.
- Sizing of the electrical components related to the voltage and the power.
- Reading of currents and voltage in different points of the circuit.
- Calculation of powers.
- Calculation of electrical efficiencies.

These converters operate on the same principle as an industrial model. They treat the electrical power supplied by a wind turbine. The output cannot be synchronized with the network but can be used in isolated site.

TECHNICAL CHARACTERISTICS

- The converter's synoptic, printed on the front, facilitates location of the components and measurement points.
- The three-phase voltage from the wind turbine is applied to CONVERTYS or CHARGEOL through 4 safety terminals 4mm dia. The wind turbine-to-converter interconnection is made using laboratory leads.
CONVERTYS : Inputs between 375 and 460V three-phase.
CHARGEOL : Inputs between 80 and 120V three-phase.
- A main switch located on the top of the box, starts and stops the converter's power supply.
- Safety terminals 4mm diam. located between each component enable the voltages and currents to be measured at each conversion step.
- A thermal-magnetic circuit-breaker protects the transformer primary against any overload.
- Output converter 500W/230V.
- A differential circuit-breaker 30mA protects the output to the use network cabled according to neutral system TT.
- Unit on casters dimensions: 700 x 500mm. Height 355mm

CONVERTYS IS SPECIALLY MADE TO WORK WITH EOLYP
CHARGEOL IS SPECIALLY MADE TO WORK WITH EOLYS-500

List of Practical Works achievable with each set:

- Principle of functioning
- The 3-phase voltage delivered by the wind turbine is galvanically separated by an isolation transformer, and then rectified by a Graetz bridge.
- This DC voltage is transformed by a DC/AC converter in an alternative voltage 230V (50Hz) / 500VA
- In case of exceeding of this power, the converter automatically offloads the output, switch on an overload indicator light, and resets 15 seconds after load reduction.

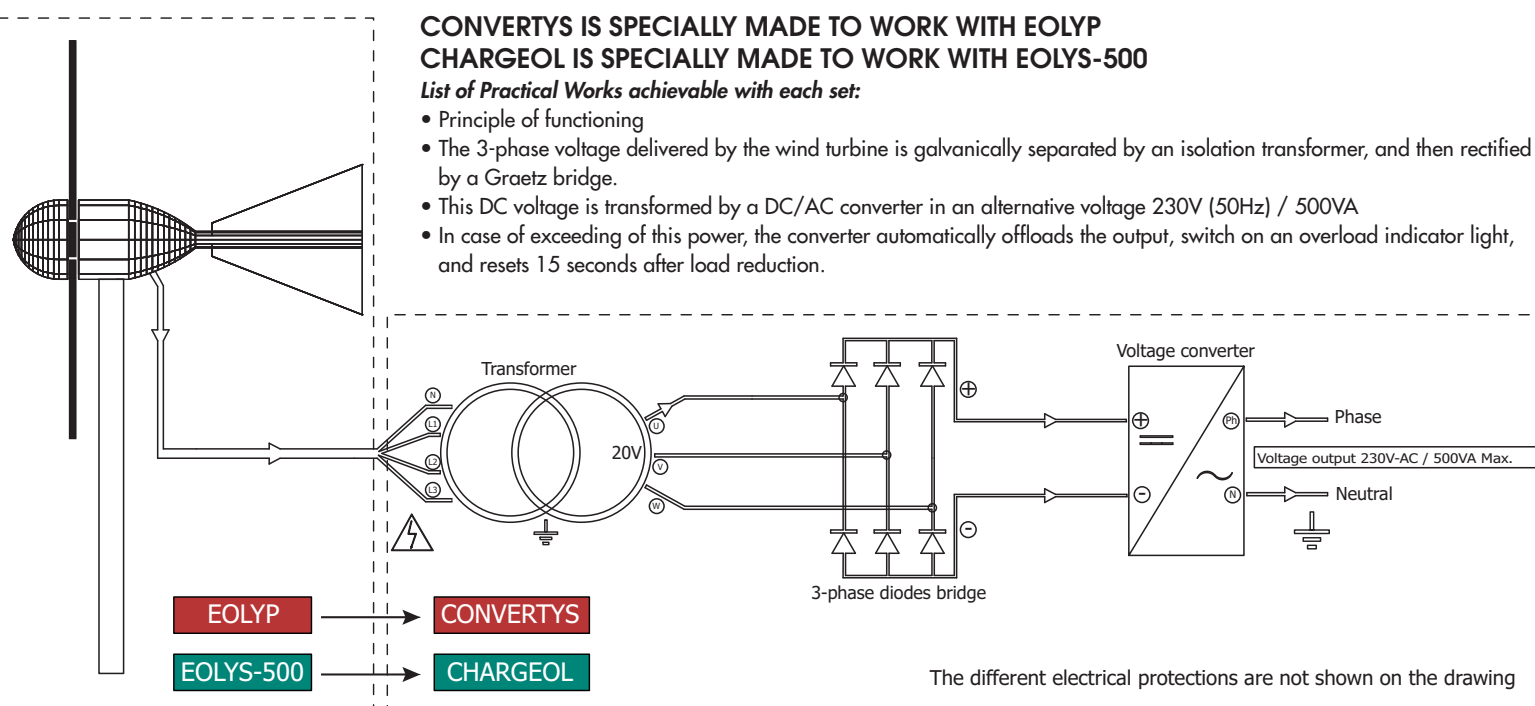

TEACHING PANEL FOR AN ENERGY FACILITY AT AN ISOLATED SITE



This teaching panel must be connected to a PV or wind voltage source. It is compatible with our SOL-200 solar panels and our EOLYS-500 wind power. Input voltage between 24Vdc and 48Vdc maximum.

ref. TAE-ISOL Bluetooth®

This learning panel supports studying a photovoltaic or wind energy source at an isolated site. TAE-ISOL is put on a table. It is equipped with 2 unfolding mobile arms which can move 70° and provide great stability. Dimensions: 700 x 600 x 400mm (unfolded arms). Delivered with a group of 4mm safety leads. Integrated batteries.

EDUCATIONAL OBJECTIVES

- Discover the various elements of a photovoltaic or wind turbine system.
- Learn and understand the safety elements present.
- Perform activities at different electrical dimensions.
- Analyze & interpret the results.
- Study the yield and incidence related to the panel positioning.
- Study the energy chain (production, storage, utilization, energy behavior).
- Wire a photovoltaic or wind facility
- Set up a Bluetooth® connection

TEACHING RESOURCES STUDENT & TEACHER

Smartphone not supplied

Bluetooth®

Requires download in Play Store or Apple Store the free application "Victron Energy".
Display on tablet or Smartphone:
- Voltage - Current of the panel / Power (W)
- Voltage - Current of the battery / Charge Current
- On-Off state charge

TEACHING PANEL FOR NETWORK INJECTION



This worktable must be connected to a PV or wind voltage source. It is compatible with our SOL-200 solar panels and our EOLYS-500 wind power. Entry voltage comprises between 75Vcc and 150Vcc. You can choose between two types of operation: total return of energy produced or restitution of energy not consumed only. TAE-RES is put on a table. It is equipped with 2 unfolding mobile arms which can move 70° and provide great stability. Dimensions: 770 x 600 x 360mm (unfolded arms). Delivered with a group of 4mm safety cords.

ref. TAE-RES

EDUCATIONAL OBJECTIVES

- Discover the various elements of a photovoltaic or wind turbine system.
- Learn and understand the safety elements present.
- Perform activities at different electrical dimensions.
- Analyze & interpret the results.
- Study the yield and incidence related to the panel positioning.
- Study the energy chain (production, utilization, energy behavior).
- Wire a photovoltaic or wind facility

TEACHING RESOURCES STUDENT & TEACHER

SOLAR AND WIND TURBINE HYBRID STATIONS

These hybrid stations include:

- 1 electrical cabinet
- 1 three-phase wind turbine 400W
- 2 photovoltaic panels
- 1 connection cable



NETWORK INJECTION AND ISOLATED SITE
ref. SOLEOL-1 Bluetooth®

NETWORK INJECTION
ref. SOLEOL-2

ISOLATED SITE
ref. SOLEOL-3 Bluetooth®



Technical datasheets on our website

EDUCATIONAL OBJECTIVES

- Discover the different components involved in a wind / solar Hybrid installation.
- Perform electrical measurements of different quantities.
- Analyze & interpret the results.
- Study the efficiency and impacts related to wind strength and sunlight.
- Study the energy chain (production, storage, use, energy behavior).
- Wire a hybrid wind / solar installation.

TEACHING RESOURCES STUDENT & TEACHER

Travaux pratiques proposés

- Record and study of the electrical characteristics of the wind turbine.
- Record and study of the electrical characteristics of solar panels.
- Calculating the efficiency of the wind / solar hybrid system.
- Realization of the diagram and wiring for restitution of the energy on the electrical grid (except SOLEOL-3).
- Realization of the diagram and cabling for use of the energy in isolated site (except SOLEOL-2).

PARTIAL OR TOTAL RESALE OPERATION

In the cabinet a DC/AC inverter converts the DC from the photovoltaic panels and/or the wind turbine to AC 220VAC 50Hz, and injects its power in synchronism into the electrical grid. This inverter is protected against any polarity reversal and any overload on the DC or AC side. When the panels are not lit, the inverter consumes no current.

Technical characteristic for the inverter coupled to the electrical grid.

INVERTER	Voltage	Max current	Power
INPUT	65~125VDC	8A	
OUTPUT	230VAC-50Hz	2,25A	500W

OPERATION IN ISOLATED SITE WITH NO RESALE

The photovoltaic and/or wind turbine current charges two 12V sealed batteries cabled in series through a charge controller. This DC voltage is either available on safety terminals at the rear of the cabinet or converted to 250VAC 50Hz by a 200W voltage converter.

Technical characteristics of converter for isolated site.

VOLTAGE CONVERTER	Voltage	Max Current	Power
INPUT	20~32 VDC	11A	210W
OUTPUT	230VAC 50Hz	1,5A	300VA



Requires download in Play Store or Apple Store the free application "Victron Energy".

Display on tablet or Smartphone:

- Voltage - Current of the panel / Power (W)
- Voltage - Current of the battery / Charge current
- On-Off state charge



Smartphone not supplied

SOLAR DATA ACQUISITION



Set of sensors, interfaces and software for the real time data monitoring of a photovoltaic installation.

ref. ACQUI-SOL2

This system allows the acquisition of data on any LANGLOIS solar models, in "isolated site" or "grid injection" mode.

Record the following physical quantities in real time:

- temperature of the solar panel surface,
- the wind speed,
- the solar radiation,
- the voltage and current produced by the solar panels
- the battery charging voltage and current ("isolated site" mode only)
- the voltage and current injected to the grid ("grid injection" mode only)
- the load consuming current, supplied from the batteries ("isolated site" mode only), or from the synchronous inverter, before returning to the networks.

An autonomous mode is also available, allowing the acquisition of data on USB memory stick (provided) plugged directly on the box.

The software (included) allows live viewing on a PC, via the USB connection, or deferred viewing. It is also possible to save the data in .csv format, in order to process them on the spreadsheet software of your choice.

COMPOSITION :

- 1 main box, to be connected to any LANGLOIS solar models.
 - MAX DC voltage input: 100VDC
 - MAX AC voltage input: 230VDC
 - MAX current input: 10A AC/DC
- 1 secondary box, waterproof, converting the data from the 3 sensors supplied, into a 4-20mA signal:
 - 1 anemometer (km/h)
 - 1 temperature sensor (°C)
 - 1 solar radiation sensor (W/m2)
- 30m connection cable between the main and secondary boxes.
- 1 set of 4mm safety test leads
- 1 USB cable for the PC connection
- 1 USB memory stick data storage in stand-alone mode
- 1 power cord 230Vac (2P+E)
- 1 user guide
- 1 visualization software. (English version only)

The software allows the consultation of data in real time or deferred. 8 channels can be displayed at a time, and each of them can be scaled to match the expected units. During viewing, it is possible to simultaneously save data to a separate disk.

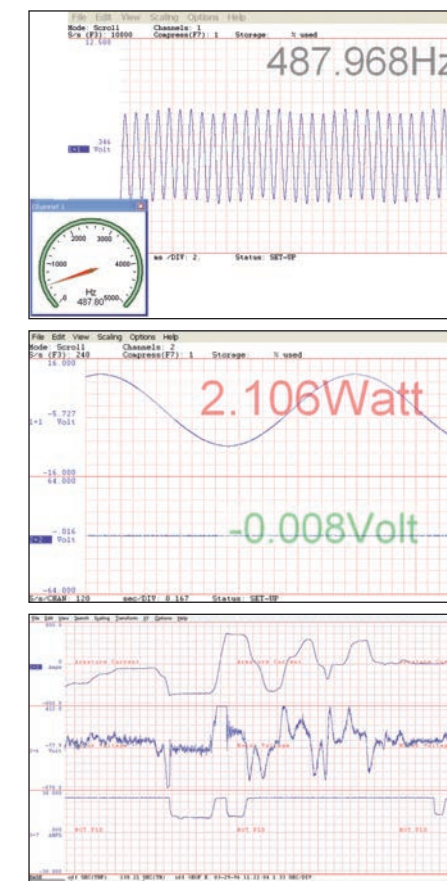

COMPLETE PACK FOR THE STUDY OF SOLAR, WIND AND HYBRID ENERGY

ref. PACK-SOLEOL-1 (included item A + B + C + D + E)

SUPPLIED WITH TEACHING RESOURCES STUDENT & TEACHER



Technical datasheets on our website

FULL DESCRIPTION OF ALL ITEMS INCLUDED IN PACK-SOLEOL-1, SEE TECHNICAL DATASHEETS.

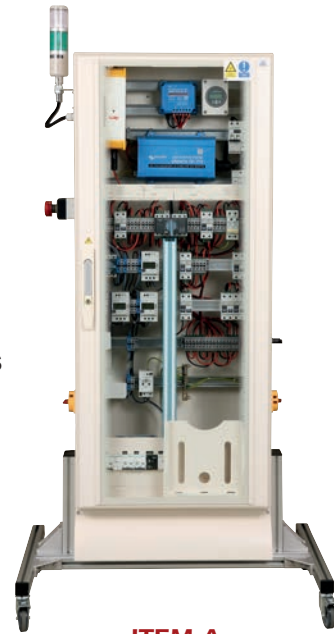

ITEM A
ELECTRICAL CABINET



ITEM B
PHOTOVOLTAIC SOLAR PANELS + PYRANOMETER



ITEM C
3-PHASE WIND TURBINE 400W



ITEM D
LOADING ZONE



ITEM E
CONVERSION OF RENEWABLE ENERGY

4 COMPLETE STUDIES POSSIBLE DEPENDING ON THE COMBINATION OF ITEMS SUPPLIED

STUDY N°1
ITEMS A + B + D
SOLAR CENTRAL UNIT WITH NETWORK INJECTION & ISOLATED SITE



STUDY N°3
ITEMS A + B + C + D
HYBRID CENTRAL UNIT WITH NETWORK INJECTION & ISOLATED SITE



STUDY N°4
ITEMS C + E
RENEWABLE ENERGY CONVERSION



STUDY N°2
ITEMS A + C + D
WIND TURBINE CENTRAL UNIT WITH NETWORK INJECTION & ISOLATED SITE



SOLAR CENTRAL UNITS WITH LOADING PANELS

SOLAR CENTRAL UNIT + LOADING PANEL
NETWORK INJECTION & ISOLATED SITE

ref. SOL-1 Bluetooth®
Electrical cabinet + 2 Solar panels + 1 Link cable

ref. HABITAT-1
Dedicating loading panel

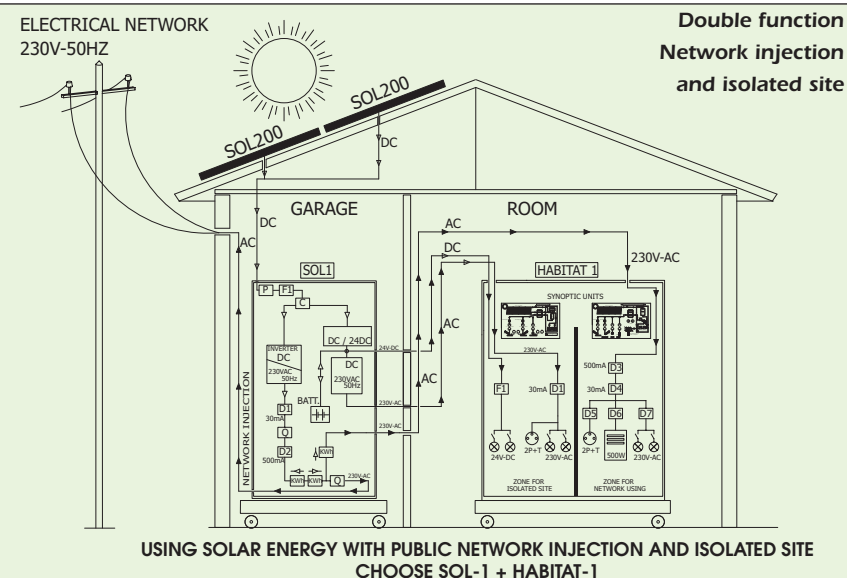

EDUCATIONAL OBJECTIVES

- Understanding the different elements of a photovoltaic system.
- Understanding the safety components involved in the system.
- Electrical measurements of different parameters.
- Analyzing and interpreting results.
- Studying the efficiency and impacts related to the positioning of the solar panels.
- Studying of the chain of solar energy (production, storage, consumption, resale, energetic behavior).
- Wiring of a photovoltaic system.

TEACHING RESOURCES STUDENT & TEACHER

PARTIAL OR TOTAL RESALE OPERATION

In the cabinet a DC/AC inverter converts the DC from the photovoltaic panels to AC 220VAC 50Hz, and injects its power in synchronism into the electrical grid. This inverter is protected against any polarity reversal and any overload on the DC or AC side. When the panels are not lit, the inverter consumes no current.

Technical characteristic for the inverter coupled to the electrical grid.

INVERTER	Voltage	Max current	Power
INPUT	65~125VDC	8A	
OUTPUT	230VAC-50Hz	2,25A	500W

SOLAR CENTRAL UNIT + LOADING PANEL
NETWORK INJECTION ONLY

ref. SOL-2
Electrical cabinet + 2 Solar panels + 1 Link cable

ref. HABITAT-2
Dedicating loading panel

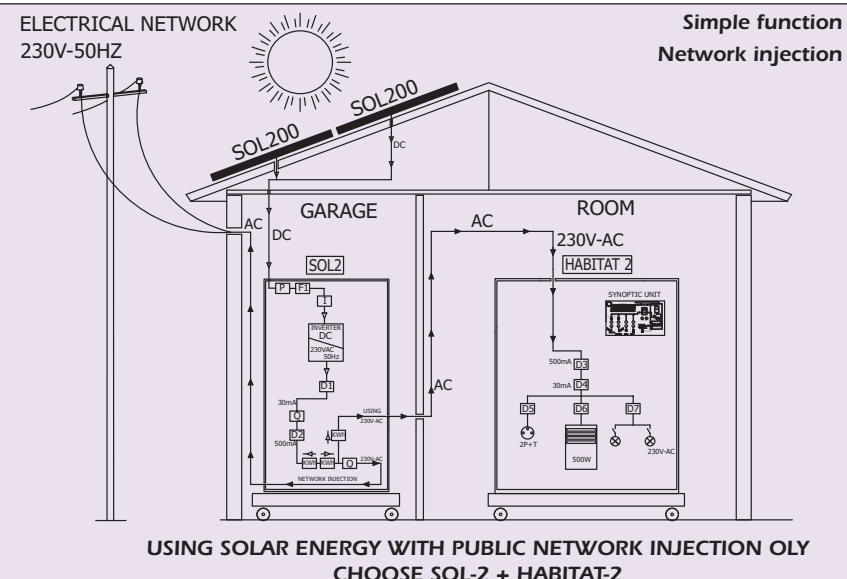

LOADING ZONE FOR USE ON SITE WITH ELECTRICITY NETWORK

- (PRESENT SUR HABITAT 1 ET HABITAT 2)
- 1 coffret standard avec protections normalisées
 - 1 disjoncteur de branchement 500mA
 - 1 disjoncteur différentiel 16A/30mA
 - 3 disjoncteurs magnétothermiques
 - 2 luminaires 100W-230VAC avec interrupteurs
 - 1 convecteur 500W
 - 1 prise 2P+T- 230VAC-50Hz
 - 1 boîtier synoptique avec bornes de sécurité pour les mesures de I et de U

SOLAR CENTRAL UNIT + LOADING PANEL
ISOLATED SITE ONLY

ref. SOL-3 Bluetooth®
Electrical cabinet + 2 Solar panels + 1 Link cable

ref. HABITAT-3
Dedicating loading panel

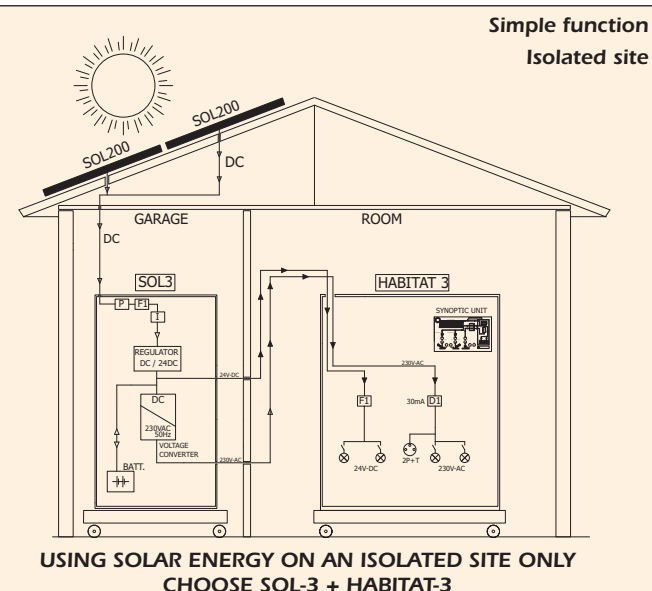

OPERATION IN ISOLATED SITE WITH NO RESALE

The photovoltaic current charges two 12V sealed batteries cabled in series through a charge controller. This DC voltage is either available on safety terminals at the rear of the cabinet or converted to 250VAC 50Hz by a 200W voltage converter.

Technical characteristics of converter for isolated site

VOLTAGE CONVERTER	Voltage	Max Current	Power
INPUT	20~32 VDC	11A	
OUTPUT	230VAC 50Hz	1,5A	300VA

LOADING ZONE FOR ISOLATED SITE USE (PRESENT ON HABITAT 1 AND HABITAT3)

- 1 differential circuit-breaker 16A/30mA
- 1 two-pole fuse holder with fuse cartridges gPV 10x38 1000V
- 2 24V DC low energy consumption light fittings with switches
- 2 light fittings 230VAC with switches
- 1 230VAC 50Hz 2P+E socket
- 1 mimic unit with safety terminals for I and U measurements in different circuits.

PORTABLE SOLAR POWER UNIT TYPE RESTITUTION NETWORK



This learning case allows the study of the return of photovoltaic energy on the national 230VAC 50Hz grid.

You can choose between two types of operation:
- total return of the energy produced
- return of the energy not consumed only.

A silkscreen represents the different components. The components are to be connected with safety cables.

This case must be connected to a 45Vmin photovoltaic voltage source. Input voltage between 45VDC and 150VDC.

EDUCATIONAL OBJECTIVES

- Discover the different elements of a photovoltaic installation network restitution.
- Apprehend and understand the security elements present.
- Perform electrical measurements of the various quantities.
- Analyze & interpret the results.
- Study the performance and the effects related to the positioning of the panels
- Study the energy chain (production, use, resale, energy behavior).
- Wiring a photovoltaic installation with grid restitution.

STUDENT + TEACHER PEDAGOGICAL FILE

Composition of the technical case

- Impact resistant polypropylene case. It can be closed without unwiring the safety cords from the front panel. Lightweight and easily transportable using its handle.
- 2 photovoltaic connectors for connecting solar panels.
- 1 surge arrester.
- 1 bipolar fuse holder with gPV cartridge protecting the solar panel circuit and use.
- 1 disconnector to isolate the circuit of the solar panels from the technical case.
- 1 UPS 500W synchronizable on the network
- 1 On / Off switch for maintenance.
- 3 energy meters
- 1 disconnector to isolate the connection to the network.
- 1 voltage controller
- 1 bipolar 30mA differential circuit breaker
- 1 230VAC-500W 50Hz output on 4mm safety terminals
- 1 230VAC-500W 50Hz output on electrical outlet
- Dimensions: 580 x 460 x 205mm

Supplied with an educational file including

- A theoretical reminder on the different types of cells and photovoltaic energy.
- The detailed wiring diagram of the solar power plant.
- Complete theoretical and practical practical work in student / teacher notebook form.
- Complete instructions for each component.

Dims of the suitcase: 580 x 460 x 205mm

Dims of the panel:
1600 x 800 x 100mm



Dims of the panel:
1600 x 800 x 100mm

ref. SOL-RES

The SOL-RES solar power plant includes:

- 1 technical case.
- 2 photovoltaic panels on tilting frames of approximately 200Wp each.
- 1 solar cable 30 m to connect the panels to the case.
- 2 portholes with 60W lamps to observe consumption.
- 1 set of safety cords.
- 1 power cord.

Features of the panel

- Open circuit voltage: 46VDC
- Short-circuit current: 6.3A
- Optimum operating voltage: 37VDC
- Optimum operating current: 5.7A
- Maximum power: 215Wc (variation of $\pm 10\%$ depending on the series)
- Sealed connections IP65 - 1000V on the rear of the panel.
- Type of cells: Monocrystalline silicon

Features of the frame

- Robust aluminum frame.
- Useful surface area of the cells 1.5m².
- Device for measuring the tilt angle
- Tilt adjustable from 5° to 70°
- Two ball joints with clamping levers for positioning the panel to the required tilt angle.
- Several SOL-200 can be coupled electrically to increase power.
- Light and easy to move.
- Dimensions Folded position: 1600 x 800 x 100mm - Weight 27kg ($\pm 10\%$ depending on the series)

PORTABLE SOLAR CENTRAL UNIT FOR ISOLATED SITE WITH ARTIFICIAL LIGHT SOURCE

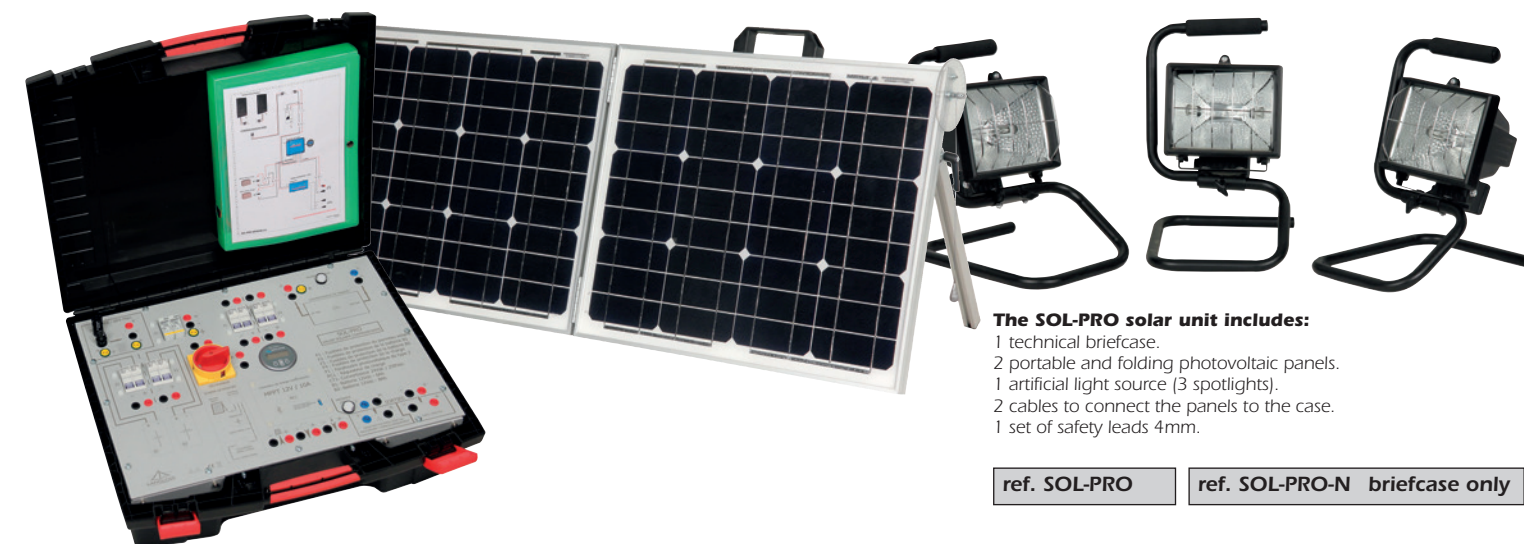

The SOL-PRO solar unit includes:

- 1 technical briefcase.
- 2 portable and folding photovoltaic panels.
- 1 artificial light source (3 spotlights).
- 2 cables to connect the panels to the case.
- 1 set of safety leads 4mm.

ref. SOL-PRO

ref. SOL-PRO-N briefcase only



Requires download in Play Store or Apple Store the free application "Victron Energy".

Display on tablet or Smartphone:

- Voltage - Current of the panel / Power (W)
- Voltage - Current of the battery / Charge current
- On-Off state charge

Smartphone not supplied



EDUCATIONAL OBJECTIVES

- Understand a photovoltaic installation of isolated site type.
- Understand the security features of the system.
- Perform wiring of a photovoltaic system.
- Perform electrical measurements of different quantities.
- Analyze & interpret the results.
- Study the performance and impact of solar panels positioning
- Study the energy chain (production, storage, use of a solar charge controller for battery).

TEACHING RESOURCES STUDENT & TEACHER

A synoptic shows the different components and the interconnections.

Connection in jump wires by safety leads 4mm.

Connection of the panels to the technical case by 2 photovoltaic leads (delivered).

Measures are possible indoor by using the artificial solar source.



Electrical characteristics of the solar unit

- photovoltaic panel (panel features):
 - nominal power P_{mpp}: 60 Wc
 - max power voltage V_{mpp}: 17.5V DC
 - max power current I_{mpp}: 3.43 A
 - open circuit voltage V_{oc}: 22V DC
 - short-circuit current I_{sc}: 3.81A
- Power injected, with artificial source: 17 Wc (24V/0.7A)
- Output voltage 230 V - 50 Hz pure sinusoidal. 120 VA max.
- Output voltage 24V DC. 180W max

Composition of the technical case

- Case made of impact-resistant polypropylene. It can be closed without disconnecting the safety cords from the front. Light and easy to carry by its handle.
- 2 photovoltaic sockets for connecting solar panels.
- 1 surge arrester.
- 1 Start/Stop switch to isolate the solar panel circuit from the technical case.
- 4 two-pole solar circuit breaker protecting the solar panel circuit, batteries and use.
- 1 24V/20A solar charge controller with display showing:
 - battery charge
 - current supplied by the solar panels
 - battery charge current
 - current consumed by the use circuit
 - battery voltage.

- 1 voltage converter pure sinusoidal 50 Hz - 24/230V AC, 120 VA. Auto-protection by resettable thermal fuse.
- 1 set of 4 mm safety cords.
- 1 output 230V AC - 120 VA on 4 mm safety terminals
- 1 use output 24V DC - 180 VA on 4 mm safety terminals
- Dimensions: 540 x 430 x 215mm

Composition of the photovoltaic panels frame

- Aluminium frame
- 2 poly-crystalline photovoltaic panels, each 30 Wc.
- 2 hinges for folding them together.
- Separate cabling for series or parallel connection.
- Useful surface area of the cells on each panel 0.2 m²
- 2 ball joints for putting the panels at the tilt angle required.
- 1 device for measuring the tilt angle.
- 2 3-metre photovoltaic cords.
- Light and easy to move (Carrying handle).
- Dimensions in unfolded position: 1140 x 470 x 200 mm
- Dimensions in folded position: 570 x 470 x 100 mm

Composition of the artificial light source

- 3 400W spotlights with variable tilt.
- Power supply 230V AC 50/60 Hz by 2-metre mains cord.
- Spotlight dimensions: 300 x 220 x h 360 mm

Supplied with CD containing

- Theoretical summary of the different types of photovoltaic cells and energy.
- The detailed wiring diagram of the solar unit
- 5 theoretical assignments and 3 complete practical assignments as student/instructor book.
- Full instructions for each component

SOLAR LED STREET LAMP

MAQ-DEL allows discovering and studying the operation of a Led solar lamp for communities or individuals for street lighting, a terrace, or any other type of application. Totally autonomous, the whole works with solar energy thanks to a set of photovoltaic components. Totally waterproof, the set can be used outdoors, thanks to large diameter wheels (200mm), to put it in a real context of use day and night.

COMPRISES

- Wheeled aluminum frame, very stable, passes easily between doorways.
- A monocrystalline photovoltaic panel of 80Wc fixed on an aluminum mat. The panel is adjustable. Allows outdoor use in good weather.
- A MPPT (Maximum Power Point Tracking) load control system and electronic device control with twilight detection and voltage level programming directly modifiable from a smartphone or tablet. A recording of the voltages, currents and powers of the solar panel, battery and LEDs in the form of data can be retrieved by an application, in multi-languages, via a Bluetooth link (visualization in the form of a bargraph).
- A solar battery 12V / 60Ah.
- A 40W lantern equipped with ultra-powerful latest generation LEDs with high light output with a color temperature of 4500K and an IRC of 70.
- An electronic LED power management device integrating a management system for reducing the luminous flux and a detection of people.
- A set of solar circuit breakers.
- A surge arrester.
- A tutorial case containing all the components: inside the case, a silkscreen (insensitive to scratches) allows to visualize through a synoptic the production chain of photovoltaic energy. The connection of the components is ensured by safety terminals 4mm allowing the student to carry out the cabling as well as electrical measurement points in complete safety.

EDUCATIONAL OBJECTIVES

- Study street lighting with LED street lamp and solar energy.
- Commission a solar system.
- Demonstrate the ecological functioning of LED technology.
- Discover the different technologies of solar panels.
- Wire photovoltaic components, mechanically install a public lighting.
- Perform electrical and mechanical maintenance on the street lamp.
- Use hand tools.
- Identify the different electrical quantities of a solar energy production line.
- Calculate the performance of the installation.
- Set up a Bluetooth network communication.
- Set up a photovoltaic system from a tablet or a smartphone.

TEACHING RESOURCES STUDENT & TEACHER

PRACTICAL WORKS

- Lessons on different solar panel technologies (Monocrystalline, Polycrystalline, Amorphous)
- Study on the positioning of solar panels for maximum efficiency.
- Mechanical attachment of the mat, the panel and the street lamp to the aluminum frame.
- Study of solar irradiation.
- Reminder on Direct, Diffused and Reflected Solar Radiation.
- Study and execution of the wiring of the solar energy chain in isolated site.
- Record currents and voltages at different points in the wiring.
- Perform measures and then calculate efficiency.
- Calculation of the discharge time of the battery according to the load.
- Configuring the application from a touch pad.
- Mechanical and electrical maintenance.

EDUCATIONAL SUPPORT

- Technical leaflet in English
- All technical "manufacturers" resources of components implemented on the system
- 12 learning scenarios in the form of Practical Works (on cd-rom) of TEACHER / STUDENT type.
- All the elements necessary for the planned practical work.
- Answer sheets for student assessment.



ref. MAQ-DEL

Bluetooth®



Adjustable solar panel
Allows indoor use with the 2 spot lights provided.
Allows outdoor use in good weather with a natural solar source.



Bluetooth® communications
Settings and visualization on smartphone and tablet.

Bluetooth®
Requires download in Play Store or Apple Store the free application "Victron Energy".

WORKSITE TRAFFIC LIGHTS - LED TECHNOLOGY - SELF-CONTAINED

Simulator of worksite traffic lights powered with solar energy. Two artificial and variable light sources simulate sunlight and enable the batteries to be recharged. Fully self-contained, operation of the FEU-LED is managed with a Schneider® PLC. One solution for manually recharging the batteries is included in the electrical unit for better organization of the explanations and practical work.

ref. FEU-LED

Bluetooth®

Bluetooth®

Requires download in Play Store or Apple Store the free application "Victron Energy".
Display on tablet or Smartphone:
- Voltage - Current of the panel / Power (W)
- Voltage - Current of the battery / Charge current
- On-Off state charge



Smartphone not supplied

EDUCATIONAL OBJECTIVES

- Study and putting into service of solar energy worksite traffic lights.
- Reminder on the different solar panel technologies.
- Wiring of the components of a photovoltaic installation at an isolated site.
- Reading the different electrical values of the production system of solar energy.
- Calculation of the efficiency of the installation.
- Programming a controller (PLC).
- Setting up a Bluetooth® connection

TEACHING RESOURCES STUDENT & TEACHER

Practical works

- Lessons on the different technologies of solar panels (Monocrystalline, Polycrystalline, Amorphous)
- Study on the positioning of solar panels for maximum output.
- Study of solar radiation.
- Reminder on Direct, Diffused and Reflected solar radiation.
- Interpretations of the theoretical curves produced from the 3 solar sensors.
- Study and creation of the wiring of a solar energy system at an isolated site.
- Reading the currents and voltages at different points of the wiring.
- Interpreting the measurements then calculation of the efficiency.
- Calculation of the discharge time of the battery according to the load.
- Creation of a controller program in contact language.
- Downloading and setting up the Bluetooth® application

Comprises

- 2 traffic lights with Red / Orange / Green LEDs.
- 2 photovoltaic panels 30W/12V Monocrystalline.
- 2 artificial sources. with light controller.
- 1 electrical cabinet with :
 - 1 Voltmeter measures the voltage of the photovoltaic panels.
 - 1 Voltmeter measures the voltage of the 2 batteries.
 - 1 Set of pushbuttons, switches and indicator lights.
 - 1 front synoptic gives the overall diagram of the system. 4mm connection terminals enable reading of U/I panels, U/I batteries, U/I charge and I charger.
 - 1 SCHNEIDER® programmable logic controller (PLC).
 - 1 solar load regulator 24VDC/15A Bluetooth®.
 - 1 battery charger 12V.
 - 2 batteries 12V-8Ah.
 - 1 set of electrical protection with gPV cartridge fuses.

Features

- 3-metre mains lead included, for the charger and artificial source.
- Dimensions: 1100 x 600 x (H) 1600mm. Weight: 68kg.
- The pole and the panels are easy to remove for going through doorways.



DUAL ENERGY ELECTRIC GATES, SOLAR OR MAINS 230VAC

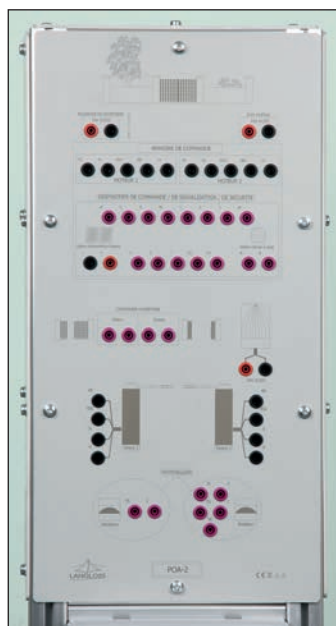

POA-1 - face côté rue



POA-1 - face côté maison

ref. POA-1 double battant

ref. POA-2 coulissant

EDUCATIONAL OBJECTIVES

- To observe and understand the operation of electric gate automation.
- Reminder about the different solar panel technologies.
- To study the operation of an assembly of solar panel, battery, charge regulator.
- To take measurements of electrical values.
- To study the operation of photo-electric cells.
- To learn how to program gate automation according to several operating criteria.
- To perform industrial maintenance operations.

TEACHING RESSOURCES STUDENT & TEACHER

Practical works

- Study and identification of the different components of the gate.
- Measurement of the current, voltage and power absorbed by the motors.
- Measurement of the current, voltage, and solar power.
- Study of the operating principle of photo-electric cells.
- Configuring the different gate operations.

Composition of the gates

- One electronic unit with control board equipped with digital display and three pushbuttons for configuring the assembly.
- One console with printed diagram of the different components including all the gate's connectors. Interconnection with safety leads supplied.
- Two gear motors 24VDC with hinged arm (version POA-1) and one motor 24VDC (version POA-2).
- One signalling light.
- One pair of photocells.
- One face equipped with 2 indicator lights to simulate lighting in the gate opening area and garden lighting.
- One two position switch for opening/closing of the gate, or a single leaf (for version POA-1).
- One unit with battery 24V-12Ah and charge regulator 24VDC



The gates POA-1 and POA-2 are supplied with an autonomous wheeled frame comprising a solar panel 30W-24VDC and two spotlights simulating the sun.

Non-solar versions
Ref. POA-11 and POA-22

Automated solar swing gates (POA-1).
Automated solar sliding gate (POA-2).
All the electrical connectors of the components (motors, cells, light, control board) are brought to one front using 4mm safety terminals. Thus the student can wire, using the safety leads, all the operations of the gate with no risk of deterioration of the screws or connectors of the components. They can also quite safely read the different voltages and currents of the system. The many operating parameters can be modified in the electrical cabinet using the programming console with digital display. There are two types of power supply wiring for the gates:

- Wiring by solar energy power supply.
The solar panel is linked to the gate's electrical cabinet. Operation is autonomous thanks to the 24VDC batteries.
- Wiring directly to the electricity mains 230VAC using its mains lead with plug 2P+E.

The assembly is supplied fully functional with examples of operation. A CD contains the user instructions and tutorials.
Dimensions:
Overall: H 1700 x W 1400 x 630mm (POA-1)
Overall: H 1700 x W 1800 x 630mm (POA-2)

SOLAR PUMPING STATION

EDUCATIONAL OBJECTIVES

- Apprehend a photovoltaic system dedicated to the power supply of a water pump.
- Perform measurements of electrical parameters.
- Analyze and interpreting results.
- Perform wiring tests with commissioning and operation validation.
- Studying the efficiency and impacts of solar panels positioning
- Studying a solar charge regulator.

TEACHING RESSOURCES STUDENT & TEACHER

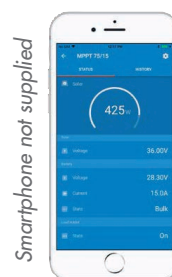

Smartphone not supplied



Requires download in Play Store or Apple Store the free application "Victron Energy".
Display on tablet or Smartphone:

- Voltage - Current of the panel / Power (W)
- Voltage - Current of the battery / Charge current
- On-Off state charge

Comprises

- 1 photovoltaic solar panel 215Wc ($\pm 10\%$) mounted on a robust frame that tilts from 5° to 70°.
Open circuit voltage: 46V DC.
Optimum operating voltage: 37V DC.
Short-circuit current: 6.3A.
Optimum operating current: 5.7A.
 - 1 30m. link cable.
 - 1 100-l tank simulates the underground water source.
 - 1 60-l transparent container acts as water reserve.
A tap simulates user consumption and returns water to the tank.
 - 1 sealed motor pump 100W- 24DVC-4A. 11.4l/min capable of pumping dry. It takes water from the tank and fills the reserve water container.
 - 2 12V/8Ah batteries supply the pumping station when sunlight is absent.
 - 1 24VDC-15A Bluetooth® regulator controls battery charging. One 2-button display accessible outside the cabinet enables configuration and viewing of the currents of the solar panel, the battery charge and the lamp and the battery voltage.
 - 1 electrical cabinet includes the cabling of all the solar components on connection terminals. A lightning arrester protects the installation and each component is protected by fused circuit-breaker type gPV. The cabling is fully marked and students can easily remove the original strand to do their cabling. Students can also take voltage and current readings. A main switch isolates the solar panel from the electrical cabinet.
 - A switched 24VDC lamp lights the area.
A wheeled frame for passing under doors.
- SOLPUITS requires no direct water connection. Once the 100-l tank is filled with water, the system is totally self-contained. Supplied cabled with detailed instructions and complete practical works. Dimensions: 760 x 830 x 1700mm. Weight 117kg.

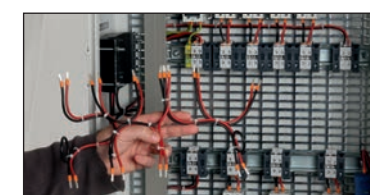

It is enough for you to remove the strand to ask to students of do the wiring.



Educational solar pumping station simulating the water supply of a population in a desert area.

ref. SOLPUITS

Bluetooth®

ref. SOLPUITS-N Vendu sans panneau.

Bluetooth®

Use your own panels with characteristics comprises between 18 and 50VDC.

RECOMMENDED OPTION FOR INDOOR OPERATION



ARTIFICIAL SOLAR SOURCE Qty1

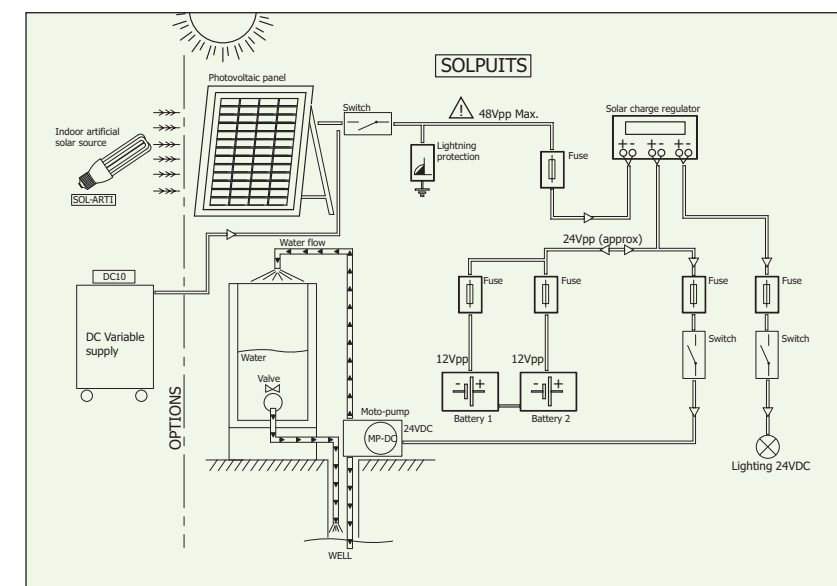

ARTIFICIAL SOLAR SOURCE



REF	Photovoltaic panel delivered installed	Side protection against the direct access to the lamps	Forced ventilation to simulate the wind	Poles and chains for zone boundary
SOL-ARTI2	Yes	Yes	Yes	No
SOL-ARTI2-N	No	Yes	Yes	No
SOL-ECO2	Yes	No	No	Yes
SOL-ECO2-N	No	No	No	Yes

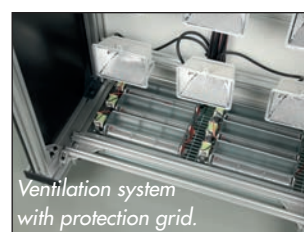

The versions without "installed photovoltaic panels" are compatible with the reference SOL-200.

This source for getting around the loss of sunlight by illuminating the solar panel with artificial light whose spectrum is close to sunlight. While not having as much luminosity as unclouded sunlight, it illuminates with sufficient intensity for the panel to generate 1/3 of its peak power Wc (corresponding to sunlight at 1 kW/m²).

The solar panel can be removed easily in order to replace a spotlight quickly if necessary.

The unit located on the back of the spotlights panel includes

- a key-operated emergency stop button for cutting the electricity supply to the spotlights
- a digital thermometer shows the temperature at the surface of the solar panel. Accuracy 1°C.
- a potentiometer for lighting adjustment, by dimmer built into the unit
- a flow control for the forced ventilation
- automatic power supply cut-off to the spotlights in the event of abnormal temperature rise of the solar panel

ELECTRICAL FEATURES OF THE SOLAR PANEL AT 25°C

LIGHTING	SOLAR	ARTIFICIAL
Maximum power	220Wc	70Wc
Open circuit voltage	43V	43V
Short-circuit current	6.2A	2.3A

- Sealed connections IP65 – 1000V
- Power supply: 230VAC.
- Dimensions/Weight: 1228 x 665mm height 1926mm.
- 4 casters including 2 with brake

PRACTICAL WORK

Adjustment of the light intensity demonstrates the correlation between the light flow and the current delivered by the photovoltaic panel, at constant voltage.

A temperature probe linked to the unit thermometer is located on the solar panel. This shows its instantaneous temperature. Any reduction of the ventilation flow causes the panel temperature to rise, and lowers the photovoltaic current in constant lighting.

Special characteristics for SOL-ARTI2 et SOL-ARTI2-N

Two opaque side panels prevent the accidental blinding of a student. With the solar panel and spotlight support they also make a closed duct for evacuating heat by an air current going from bottom to top. Centrifugal fans, located in the bottom part, inject fresh air that runs up the panel.

Grids in the bottom and top parts let the air flow pass evacuating the heat, and prevent accidental contact by hand with a burning spotlight or with the fan blades.

The versions SOL-ECO2 and SOL-ECO2-N have no lateral protection, no forced ventilation. Versions delivered with 4 poles and 2 chains for the delimitation of a safety zone around the system.



SOL-ECO2, protection by bounded safety zone

ARTIFICIAL SOLAR SOURCE : COMMUNICATING VERSION

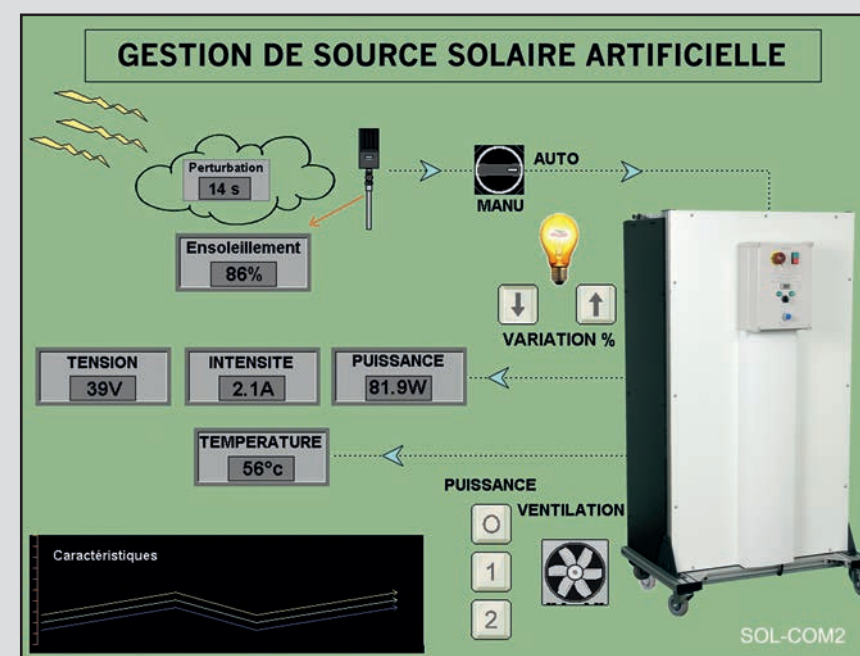

SUPERVISION SOFTWARE SUPPLIED

Vijeo designer of Schneider®.

Allows:

- the acquisition and the display of PLC variables
- the supervision and the process control
- the programming of your own supervision
- the creation of your own Ethernet computer network

Displays:

- The values of U(V) / I(A) / P(W) supplied by the solar panel
- The temperature (°C) of the solar panel
- The level of sunshine (solar radiation)
- The level of ventilation

Controls:

- The level of the artificial light intensity
- The disturbance which simulate the passing of a cloud (you can select the duration if the effect).
- The level of ventilation

PRACTICAL WORKS

- Theoretical study on the solar panel functioning
- Theoretical study on the solar panel positioning
- The Ethernet networking of the system
- The influence of the panel temperature on the intensity supplied

- The programming of the PLC
- The setting of the analog cards
- The creation of a supervision programming

PHOTOVOLTAIC/WIND KIT FOR ENERGY RESTITUTION

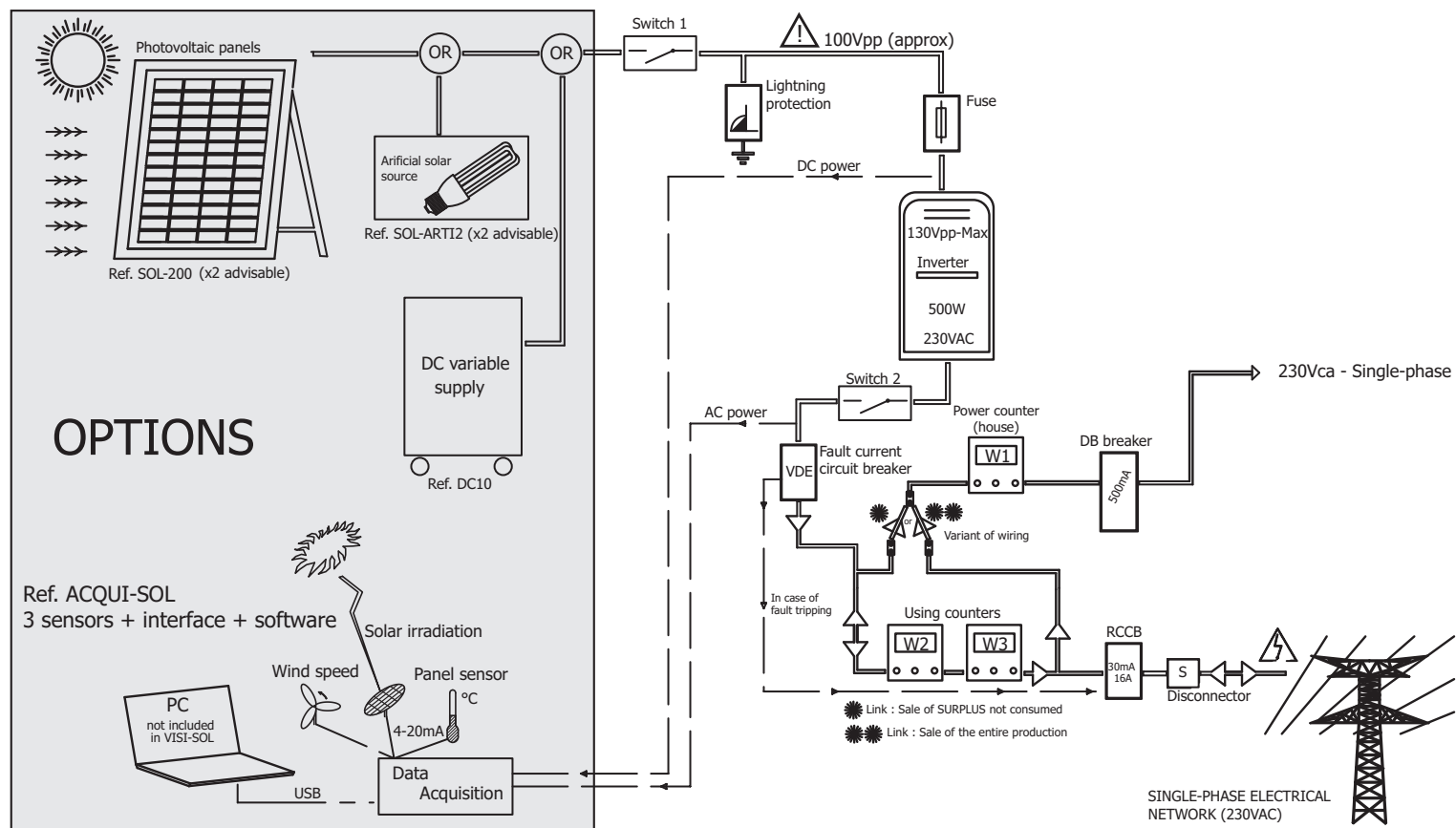

COMPOSITION OF THE KIT

- 2 photovoltaic switches 0/1 - 32A/500VDC - 3 Poles.
 - 1 500VDC lightning arrester.
 - 1 photovoltaic fuse holder 1000VMax. 2 poles. 10x38mm.
 - 4 gPV 1000V photovoltaic fuse cartridges. 10x38mm.
 - 1 network inverter 500W.
- Automatic synchronizati on the 230VAC-50Hz network.
Input voltage from 65 to 130VDC.
Thermal protection integrated in the housing.
- 3 single-phase 80A modular energy meters.
- Measurement and visualization of total and partial energy.
Measurement of electrical parameters I,V,f, Powers, power factor. Resolution 10Wh, 10VARh.
- 1 voltage control relay.
 - 1 switch disconnector 25A - 5.5kW/400V.
 - 1 bipolar 30mA/16A differential circuit breaker.
 - 1 bipolar branch circuit breaker 500mA, 230 V AC, 15/30/45 A.
 - 1 male 2P+E plug.
 - 1 modular 230V 2P+E socket outlet
 - 1 set of 10mm² connection terminals.
 - 1 set of 4-6mm² photovoltaic connectors.
 - 1 sheet of 10 photovoltaic labels indicating the various safety operations.
 - 1 file on CD: detailed instructions for each component, wiring diagram as well as practical exercises.
- Works with panels with characteristics between 35 and 150VDC.



ref. KX-EDU

TEACHING RESSOURCES STUDENT AND TEACHER

OPTIONS

- Ref. SOL-200 (2 panels recommended) 200W photovoltaic panel on tilting stand with protractor for measuring the angle of inclination.
- Ref. SOL-CAB30 Connection cable for photovoltaic panels 30m 3G6mm².
- Ref. EOLYS-500 450W three-phase wind turbine.
- Ref. ACQUI-SOL Interface with 3 sensors and acquisition software to record the electrical characteristics of the installation.
- Ref. DC10 DC power supply 0 - 220 volts - 10A protected. Simulates panels.
- Ref. SOL-ART12 Artificial solar source.
- Ref. HABITAT-2 Habitat panel in use on site with electrical network.

STUDY OF THE FEEDING OF PHOTOVOLTAIC ENERGY NATIONAL NETWORK



Set of photovoltaic modules (H-250mm) and solar panels for studying a solar installation with energy feeding to the 230V AC grid.



EDUCATIONAL OBJECTIVES

- Learn about a photovoltaic installation with energy feeding to the grid.
- Study the types of energy feeding to the grid, e.g. total or partial.
- Learn about and understand the photovoltaic elements present.
- Create the wiring of a photovoltaic installation.
- Take the electrical measurements of the different values.
- Study the efficiency and incidences related to the positioning of the solar panels.
- Study the use of a grid inverter and energy meter.

ref. QUICK-MPLUS

ref. QUICK-M

without frame and console

TEACHING RESSOURCES STUDENT AND TEACHER

The set can be supplied without the two solar panels, please ask for details.

Proposed Practical Works

- Creation of the complete wiring diagram for feeding all the energy produced by the panels.
- Creation of the complete wiring diagram for feeding the non-consumed energy produced by the panels.
- Take the measurements of voltage, current and power of the solar panels.
- Take the measurements of the fed voltage, current and power.
- Calculation of the efficiency of the installation.

Comprises

- 1 Coupler module of photovoltaic terminals to 4mm terminals.
 - 1 Surge arrester module.
 - 1 Circuit switching module.
 - 1 Double fuse holder module 10x38 gPV.
 - 3 Single-phase energy meters modules 63A. Reset key. Resolution 0.1kW
 - 1 Grid inverter module 500W. Automatic synchronization with the grid 230V. Input voltage from 65 to 125V DC. Thermal protection integral to the box.
 - 1 Module of photovoltaic two-pole circuit-breaker with fault current VDE0126.
 - 1 Grid synchronization switch module.
 - 1 Module with outlet 2P+E, 4mm terminals.
 - 1 Analogue voltmeter/ammeter module.
 - 1 Digital voltmeter module.
 - 1 Digital ammeter module.
 - 2 Solar panels 200Wc on frame that tilts from 5° to 70°.
 - 1 Photovoltaic cable, 30 metres.
 - 1 set of safety leads for carrying out the different practical works.
 - 1 frame with wheels (H x W x D): 1610 x 940 x 500mm equipped with rack for leads
 - 1 single-phase power console:
 - 1 thermal magnetic circuit breaker (16A)
 - 1 Emergency stop push button with key
 - 1 Push button + LED indicator
 - 1 230V single-phase output on 4mm safety terminals
 - 2 230Vac sockets (2P + E) + 12 230Vac sockets (2P + E), at the back
- Mains power supply 230V - 50/60Hz. 3-metre lead with plug 2P+E.



Sockets on the back of the console for connecting the modules

PHOTOVOLTAIC/WIND KIT FOR ENERGY RESTITUTION

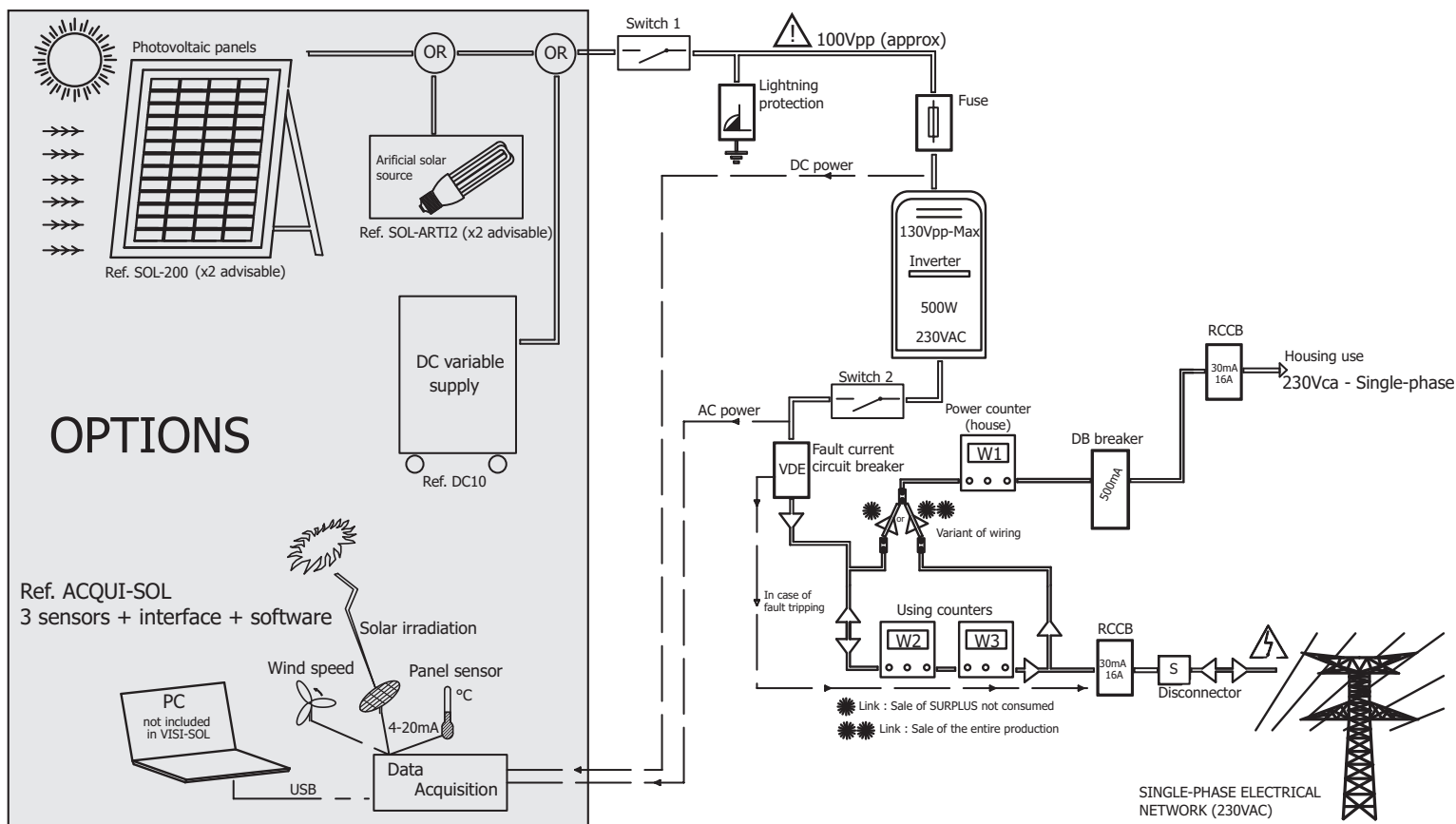

OPTIONS

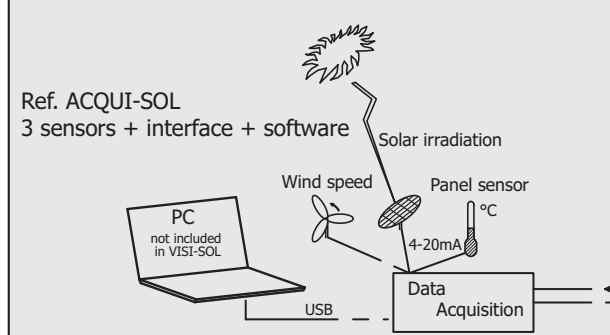

ref. KX-EDU

TEACHING RESSOURCES STUDENT AND TEACHER

- OPTIONS**
- Ref. SOL-200 (2 panels recommended) 200W photovoltaic panel on tilting stand with protractor for measuring the angle of inclination.
 - Ref. SOL-CAB30 Connection cable for photovoltaic panels 30m 3G6mm².
 - Ref. EOLYS-500 450W three-phase wind turbine.
 - Ref. ACQUI-SOL Interface with 3 sensors and acquisition software to record the electrical characteristics of the installation.
 - Ref. DC10 DC power supply 0 - 220 volts - 10A protected. Simulates panels.
 - Ref. SOL-ART12 Artificial solar source.
 - Ref. HABITAT-2 Habitat panel in use on site with electrical network.

- COMPOSITION OF THE KIT**
- 2 photovoltaic switches 0/1 - 32A/500VDC - 3 Poles.
 - 1 500VDC lightning arrester.
 - 1 photovoltaic fuse holder 1000VMax. 2 poles. 10x38mm.
 - 4 gPV 1000V photovoltaic fuse cartridges. 10x38mm.
 - 1 network inverter 500W. Automatic synchronizatin on the 230VAC-50Hz network. Input voltage from 65 to 130VDC. Thermal protection integrated in the housing. 1 bipolar 30mA-10A differential circuit breaker.
 - 3 single-phase 80A modular energy meters. Measurement and visualization of total and partial energy. Measurement of electrical parameters I,V,f, Powers, power factor. Resolution 10Wh, 10VARh.
 - 1 EMS voltage control relay conforming to Standard VDE0126. Operating voltage from 196 to 250VAC.
 - 1 switch disconnector 25A - 5.5kW/400V.
 - 2 bipolar 30mA/16A differential circuit breakers.
 - 1 bipolar branch circuit breaker 500mA, 230 V AC, 15/30/45 A.
 - 1 male 2P+E plug.
 - 1 modular 230V 2P+E socket outlet
 - 1 set of 10mm² connection terminals.
 - 1 set of 4-6mm² photovoltaic connectors.
 - 1 sheet of 10 photovoltaic labels indicating the various safety operations.
 - 1 file on CD: detailed instructions for each component, wiring diagram as well as practical exercises. Works with panels with characteristics between 35 and 150VDC.

STUDY OF THE FEEDING OF PHOTOVOLTAIC ENERGY NATIONAL NETWORK



Set of photovoltaic modules (H-250mm) and solar panels for studying a solar installation with energy feeding to the 230V AC grid.



- EDUCATIONAL OBJECTIVES**
- Learn about a photovoltaic installation with energy feeding to the grid.
 - Study the types of energy feeding to the grid, e.g. total or partial.
 - Learn about and understand the photovoltaic elements present.
 - Create the wiring of a photovoltaic installation.
 - Take the electrical measurements of the different values.
 - Study the efficiency and incidences related to the positioning of the solar panels.
 - Study the use of a grid inverter and energy meter.

ref. QUICK-MPLUS	
ref. QUICK-M	without frame and console
TEACHING RESSOURCES STUDENT AND TEACHER	

The set can be supplied without the two solar panels, please ask for details.

- Proposed Practical Works**
- Creation of the complete wiring diagram for feeding all the energy produced by the panels.
 - Creation of the complete wiring diagram for feeding the non-consumed energy produced by the panels.
 - Take the measurements of voltage, current and power of the solar panels.
 - Take the measurements of the fed voltage, current and power.
 - Calculation of the efficiency of the installation.

- Comprises**
- 1 Coupler module of photovoltaic terminals to 4mm terminals.
 - 1 Surge arrester module.
 - 1 Circuit switching module.
 - 1 Double fuse holder module 10x38 gPV.
 - 3 Single-phase energy meters modules 63A. Reset key. Resolution 0.1kW
 - 1 Grid inverter module 500W. Automatic synchronization with the grid 230V. Input voltage from 65 to 125V DC. Thermal protection integral to the box.
 - 1 Module of photovoltaic two-pole circuit-breaker with fault current VDE0126.
 - 1 Grid synchronization switch module.
 - 1 Module with outlet 2P+E, 4mm terminals.
 - 1 Analogue voltmeter/ammeter module.
 - 1 Digital voltmeter module.
 - 1 Digital ammeter module.
 - 2 Solar panels 200Wc on frame that tilts from 5° to 70°.
 - 1 Photovoltaic cable, 30 metres.
 - 1 set of safety leads for carrying out the different practical works.
 - 1 frame with wheels (H x W x D): 1610 x 940 x 500mm equipped with rack for leads
 - 1 single-phase power console:
 - 1 thermal magnetic circuit breaker (16A)
 - 1 Emergency stop push button with key
 - 1 Push button + LED indicator
 - 1 230V single-phase output on 4mm safety terminals
 - 2 230Vac sockets (2P + E) + 12 230Vac sockets (2P + E), at the back
 - Mains power supply 230V - 50/60Hz. 3-metre lead with plug 2P+E.



Sockets on the back of the console for connecting the modules

PHOTOVOLTAIC KIT FOR ISOLATED SITE

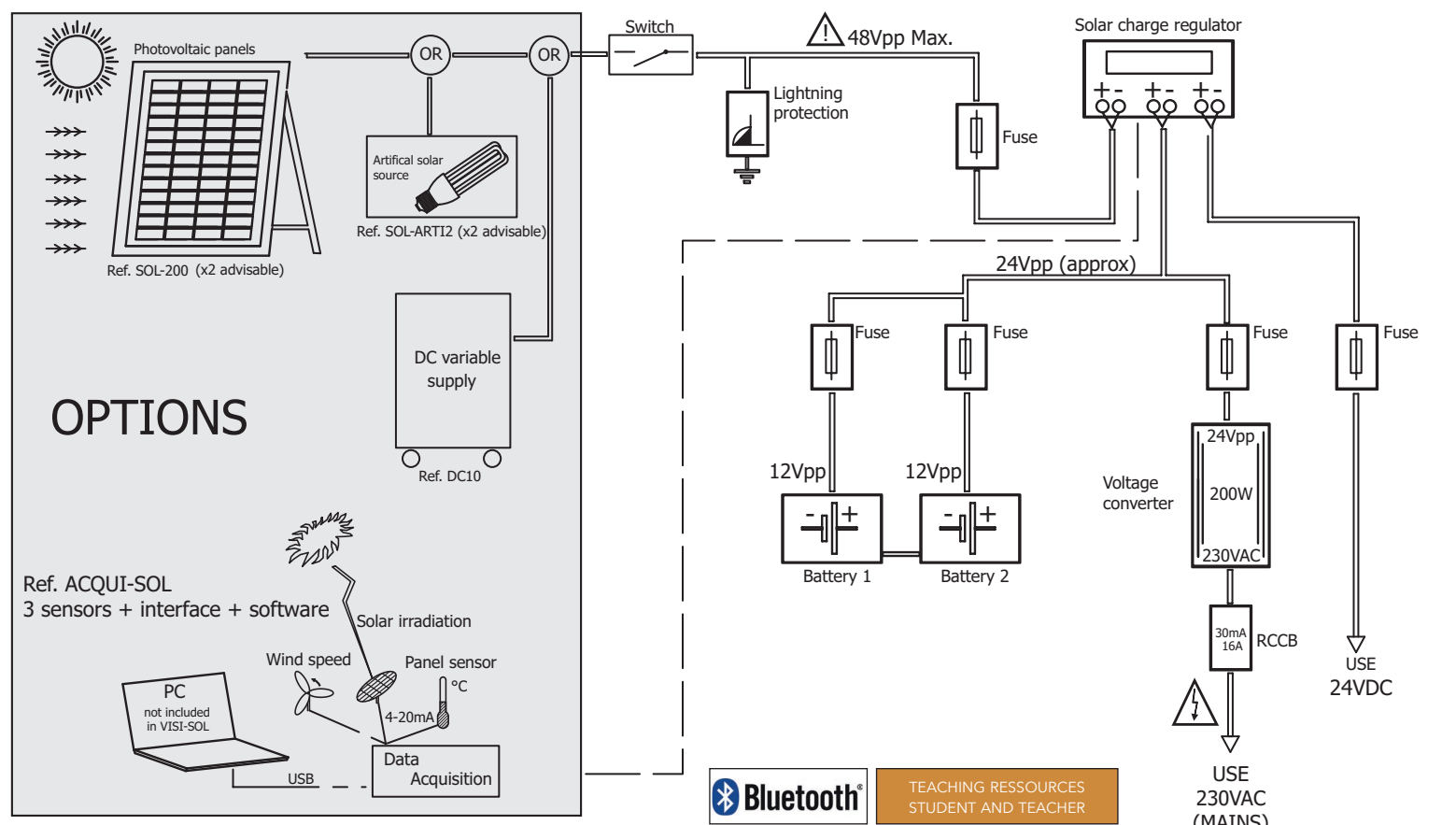

 TEACHING RESSOURCES
 STUDENT AND TEACHER

COMPOSITION DU KIT

- 1 photovoltaic switch 0/1 - 32A/500VDC - 3 Poles.
- 1 500VDC lightning arrester.
- 1 pure sine voltage converter 50Hz- 24/230VAC of 120VA. Self-protection by resettable thermal fuse
- 5 photovoltaic fuse holders 1000VMax. 2 poles. 10x38mm.
- 12 gPV 1000V photovoltaic fuse cartridges. 10x38mm.
- 2 sealed solar batteries of 12VDC - 14Ah
- 1 bipolar 30mA/16A differential circuit breaker.
- 1 bipolar 3A circuit breaker.
- 1 undervoltage coil
- 1 emergency stop
- 1 male 2P+E plug.
- 1 solar charge controller communicating via Bluetooth 24V/15A with display indicating:
 - battery charging
 - the intensity provided by the solar panels
 - battery charge current
 - the current consumed by the load circuit
 - battery voltage
- 1 set of 10mm² connection terminals.
- 1 set of 4-6mm² photovoltaic connectors.
- 1 sheet of 10 photovoltaic labels indicating the various safety operations.
- 1 file on CD: detailed instructions for each component, wiring diagram as well as practical exercises. Works with 75VDC maximum specification panels (not supplied).

OPTIONS

- Ref. SOL-200 (2 panels recommended) 200W photovoltaic panel on tilting stand with protractor for measuring the angle of inclination.
- Ref. SOL-CAB30 Connection cable for photovoltaic panels 30m 3G6mm².
- Ref. ACQUI-SOL Interface with 3 sensors and acquisition software to record the electrical characteristics of the installation.
- Ref. DC10 DC power supply 0 - 220 volts - 10A protected. Simulates panels.
- Ref. SOL-ARTI2 Artificial solar source.
- Ref. HABITAT-3 Habitat panel in use on an isolated site.

STUDY OF PHOTOVOLTAIC ENERGY ON AN ISOLATED SITE

EDUCATIONAL OBJECTIVES

- Apprehend a photovoltaic installation of isolated site type.
- Apprehend and understand the photovoltaic elements involved.
- Perform wiring of a photovoltaic system.
- Perform the electrical measurements of the different values.
- Study the efficiency and incidences of solar panels positioning.
- Study the energy system (production, storage, charge, discharge).
- Study the use of a solar charge controller for batteries.

ref. QUICK-NPLUS

ref. QUICK-N

version sans châssis ni pupitre

TEACHING RESSOURCES STUDENT AND TEACHER

Proposed Practical Works

- Creation of the complete wiring diagram.
- Perform parameter setting of the battery charge controller.
- Perform the measurements of voltage, current and power of the solar panels.
- Perform the measurements of voltage, current and power at output 24V DC.
- Calculation of the efficiency of the installation.
- Calculation of the charge/discharge time of the battery.

Comprises

- 1 Coupler module of photovoltaic terminals to 4mm terminals.
- 1 Surge arrester module.
- 1 Circuit switching module.
- 3 Double fuse holder modules 10x38 gPV.
- 1 Solar charge regulator module 24V DC - 20A
- 1 Voltage converter module 350VA - 24V DC - 230V AC on outlet 2P+E.
- 2 Voltmeter/ammeter analogue display modules.
- 1 Two batteries module 12V - 12Ah.
- 2 Solar panels 200Wc on frame that tilts from 5° to 70°.
- 1 Photovoltaic cable of 30 meters.
- 1 set of safety leads for carrying out the different practical works.
- 1 frame with wheels (H x W x D): 1610 x 940 x 500mm equipped with rack for safety leads
- 1 single-phase power console:
 - 1 thermal magnetic circuit breaker (16A)
 - 1 Emergency stop push button with key
 - 1 ON push button + LED indicator
 - 1 230V single-phase output on 4mm safety terminals
 - 2 230Vac sockets (2P + E) + 12 230Vac sockets (2P + E), at the back
- Mains power supply 230V - 50/60Hz. 3-meter lead with plug 2P+E.

The set can be supplied without the two solar panels, please ask for details.



Sockets on the back of the console for connecting the modules



Set of photovoltaic modules (H-250mm) and solar panels for studying a solar installation on an isolated site.



BOXED COMPONENTS FOR STUDYING SOLAR ENERGY

These components are made safe in plastic boxes with transparent covers. They are perfectly visible and the cabling is facilitated by the different safety terminals Ø4mm. Each box is supplied with detailed instructions

OPTIONS

- Ref. SOL-200 Photovoltaic panel 200W on tilting foot with device for measuring the tilt angle
- Ref. SOL-CAB30 Connection cable for photovoltaic panels 30m 3G6mm²
- Ref. ACQUI-SOL Interface with 3 sensors and acquisition software to read the installation's electrical characteristics.
- Ref. DC10 Power supply DC 0 - 220V - 10A protected. Simulates the panels.
- Ref. SOL-ARTI2 Source of artificial sunlight.

SEALED SOLAR BATTERIES



ref. CIA-BAT24

- Lot of 2 sealed solar batteries 12V-12Ah.
- Separate cabling of the two sources for putting the 2 batteries in series or parallel.
- L x W x h: 280x190x130mm

LIGHTNING ARRESTER PROTECTION



ref. CIA-PRF

- Lightning arrester protection for 2-pole DC circuit - 500VDC.
- L x W x h: 180x80x90mm

INTERFACE FOR SAFETY TERMINALS



ref. CIA-BORN

- Interface unit for converting 2 photovoltaic type terminals into safety terminals 4mm.
- 32A Max.
- L x W x h: 105x80x90mm

MODULAR ENERGY METER



ref. CIA-CPT

- Single-phase modular energy meter 63A.
- Gauges key kW.h/kW/Partial.
- Reset key.
- Resolution 0.1kW
- L x W x h: 170x140x100mm

PHOTOVOLTAIC SWITCH

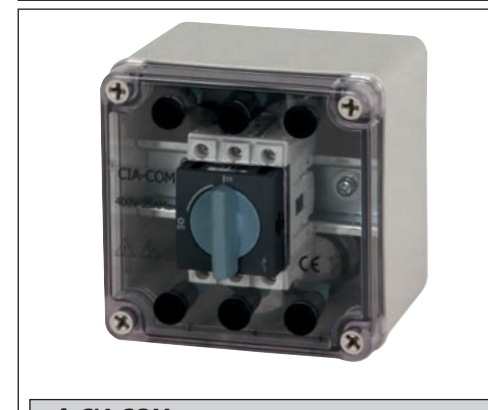

ref. CIA-COM

- Photovoltaic switch 500VDC.
- 3-pole - 32A.
- Front operation control 90°
- Position: O/I
- L x W x h: 120x120x100mm

SOLAR CHARGE REGULATOR



ref. CIA-REG-C Bluetooth

- Solar charge regulator (Bluetooth).
- Max current 15A.
- Operating voltage 12V or 24V.
- Input voltage range from 6.9 to 17.2VDC for 12VDC and from 17.3 to 43VDC for 24VDC
- 48VDC Max solar panel input
- Settings from a smartphone: battery and operating algorithms charging output with street light mode day / night mode
- Live data display (voltage, input / output power, etc.) or history via bar graph
- Protection against short circuits and overheating
- The display connected to the MPPT provides live viewing of system status information, including solar power in watts, battery voltage, charging current and more; to consult the history of values recorded continuously or of values over the last 30 days and configure the charge controller
- LxWxH: 200 x 200 x 130mm

NETWORK INVERTER



ref. CIA-OND05

- Network inverter 500W.
- Automatic synchronization on the network 230VAC-50Hz.
- Input on solar connector Male / Female coded
- 2 cables of 1 meter with polarized male & female solar connector to 4mm double well safety terminal to allow connection to the input safety plug.
- Output on 4mm safety terminal
- Network monitoring integrated into the box
- Kits of 2 forks, fitting tool adapted to the solar connector
- LxWxH: 176 x 243 x 71mm

VOLTAGE CONVERTER



ref. CIA-CONV

- Pure sine-wave voltage converter 300W.
- Input voltage, on safety terminals, from 18.4 to 34VDC and 230VAC-50Hz +/- 3% output on 1P socket
- Output for one load only
- On / off button on the output side
- Short circuit output and ripple protection direct current too high
- LxWxH: 86 x 165 x 260mm

PHOTOVOLTAIC 2-POLE FUSE HOLDER

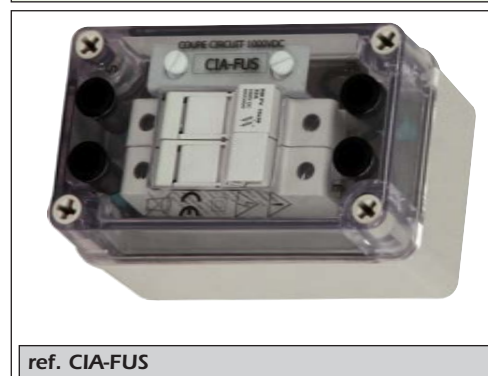

ref. CIA-FUS

- Photovoltaic two-pole fuse holder 10x38mm,
- 2-pole for DC.
- Fuse replacement without opening box
- Max: 1000VDC.
- L x W x h: 130x80x90mm
- Supplied without fuse cartridges gPV. Option Fuse gPV 10x38 1000V: Ref. SBT-FUS10

VOLTAGE CONTROLLER



ref. CIA-VDE

- Bipolar photovoltaic/wind circuit breaker fault current EMS compliant to VDE0126 Standard
- Adjustable without opening the case
- 16A-30mA range
- Operating voltage from 196 TO 250VAC
- LxWxH: 170 x 140 x 100mm

PHOTOVOLTAIC INVERTER



ref. CIA-INV

- Photovoltaic inverter switch 500VDC.
- 6-pole - 32A.
- Front operation control 190°
- Position I/O/I
- L x W x h: 170x140x100

For instance :

2 x CIA-COM	1 x CHT-V6	6 leads 402S-R
1 x CIA-PRF	1 x CIA-SEO	15 leads 402S-N
1 x CIA-FUS	2 x CIA-MT37	10 leads 402S-B
4 x SBT-FUS12	2 x SOL-200	2 leads 404S-R
1 x CIA-OND05	1 x SOL-CAB30	6 leads 404S-N
3 x CIA-CPT		2 leads 404S-B
1 x CIA-BORN		4 leads TE-200
1 x CIA-VDE		

set of components for the study of the wiring of a solar energy system with energy release on the electrical network 230 Vac (mains).

Tips and wiring diagrams provided

OPTION ACCROCHAGE SUR RAILS



Option accrochage pour une fixation rapide sur un rail universel. Vous pouvez ainsi fixer vos différents composants CIA sur une grille et faciliter les câblages et les essais. Il vous suffit d'ajouter -FIX à la fin de la référence du composant sélectionné. Ex : CIA-VDE-FIX

1 x CIA-COM	1 x CIA-MT37
1 x CIA-BAT24	2 x SOL-200
1 x CIA-PRF	1 x SOL-CAB30
5 x CIA-FUS	15 leads 402S-R
12 x SBT-FUS12	15 leads 402S-N
1 x CIA-REG	2 leads 404S-R
1 x CIA-CONV	2 leads 404S-N
1 x CIA-BORN	2 leads TE-200

For instance : set of components for the study of the wiring of a solar energy system for isolated site using batteries.

Tips and wiring diagrams provided

SOLAR PUMP 24VDC - 3.5A



ref. CIA-POMP

- Self-priming
- Power supply on safety terminals

STUDY OF FAULT DIAGNOSTICS ON A SOLAR INSTALLATION

SOL-DIAG is a solar model for producing faults at different points of the wiring. The assembly is comprised of an aluminium frame on casters, a wiring frame with solar components, a set of switches and a separate photovoltaic panel.

The faults can be produced by the instructor by rotating single switches.

The voltage of the circuit does not exceed 30VDC. Thus students can take measurements or perform tests in complete safety, regardless of the fault type.

EDUCATIONAL OBJECTIVES

- To learn and understand the operation of a photovoltaic installation.
- To diagnose faults on a photovoltaic installation in isolated site.
- To take the measurements of the different electrical values.
- Analysing and interpreting the results.
- To study the efficiency of the solar panels.
- To study the energy system (production, storage, use, energy performance).

TEACHING RESSOURCES STUDENT & TEACHER

Practical works

- Identification of the different components of the energy system.
- Producing the electrical diagrams.
- Calculation of the efficiency of the photovoltaic panel.
- Reading the currents and voltages in the circuit.
- Finding the faults on the circuit using measuring devices.

Model supplied wired, operational, with teaching manual on CD.

Autonomous power supply. Recharges the batteries using the supplied charger.

Composition of the model

- Frame with casters, two with brakes
- One wiring frame equipped with:
 - 1 surge arrester
 - 6 two-pole fuse holders
 - 1 maintenance switch
 - 2 batteries 12VDC-8Ah
 - 1 20A charge regulator with LCD
 - 1 voltage converter 24VDC/230VAC-200VA
 - 2 bulkhead lights, one with 230VAC, the other with 24VDC
 - 1 battery charger 12VDC
- One unit containing 7 switches for creating faults
 - One key operated flap for hiding the switches
- Melamine shelf 750x400mm
- Dimensions of the frame: H 1800 x 800 x 700mm



Flap for access to the switches

Composition of the solar source

- Solar panel 30W-24VDC on frame with casters (2 with brakes)
- 2 projectors for simulating the sun's rays
- 2 photovoltaic cables 3 metres for linking the panel to the wiring frame
- Dimensions of the panel frame: H 1300 x 900 x 620mm



FABRIQUE FRANCE
FRENCH MANUFACTURE

Model + Solar source (panel and spotlights) for indoor operation

ref. SOL-DIAG

aref. SOL-DIAG-N Sold without solar panel

Use your own panels with specifications comprises between 18 & 50VDC.

DESCRIPTION OF THE FAULTS

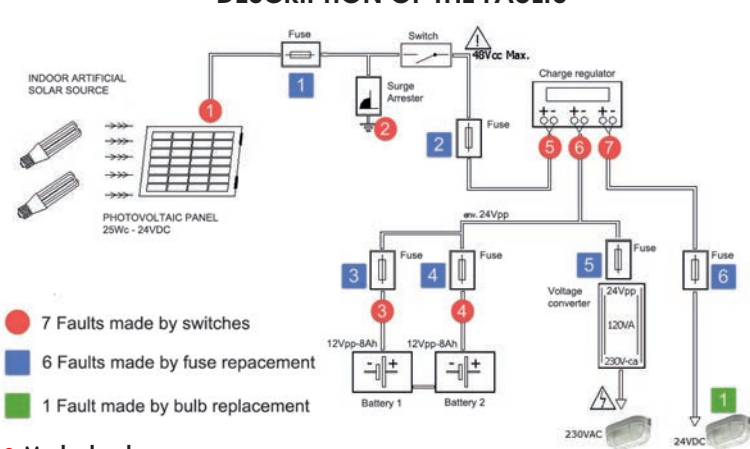

Marked red

Faults 1/2/4: switch for wire break
 Fault 3: Insertion of high resistance in series
 Faults 5/6/7: faults on the 3 inputs of an electronic component inside the charge regulator. The voltages are present on the + and - terminals but the regulator does not work.

Marked blue

Faults 1/2/3/4/5/6: change of fuse with defective one.
 6 OS fuses are supplied with the model.

Marked green

Fault 1: change of bulb 24V with a defective one.
 Defective bulb supplied with the model.

INSTALLATION TESTER PACK



The SOLAR-150 pack allows you to control electrical safety and performance of the photovoltaic installations. Safe and easy to use, it combines many functions.

ref. SOLAR-150



Functions of the PV150 main box:

- Ground continuity continuity measurement
- Calculation of continuous instantaneous power
- Instantaneous current measurement
- Insulation resistance measurement 250/500/1000V
- Open circuit voltage measurement up to 1000Vdc
- Measurement of short-circuit current up to 15ADC

All this information can be stored in the memory of the device (200 complete tests) and downloaded to PC in CSV format thanks to its USB connectivity. Possibility of creating certificates and professional test reports using the supplied software.

Main Features

Weight	1.04kg
Dimensions	26.4 x 10.7 x 5.8cm
Backlit display	LCD
Power supply	6 x 1.5V AA
Battery life	>1000 measurements
Auto power off.	Programmable
Software	In ENGLISH

Functions of the SURVEY 200 secondary unit:

- Instantaneous irradiance measurement
- Instantaneous measurement of ambient temperature
- Instant measurement of panel surface temperature
- Instantaneous measurement of the inclination of the panels.

All this information can be stored in the memory of the device (200 complete tests) and downloaded to a PC in CSV format thanks to its USB connectivity.

Scope of supply

- 1 main device
- 1 secondary device for irradiance and temperature measurements.
- 1 AC/DC current clamp.
- 2 MC4 test lead adapters.
- 2 measurement leads with MC4 fuse
- 2 tests leads, with test probes and detachable crocodile clips (4mm).
- 1 quick start guide.
- 1 UKAS calibration certificate.
- SolarCert and Seaward PC software (English only)
- 1 mounting bracket for the second measuring device
- 1 robust transport bag

SOLAR ANALYSER

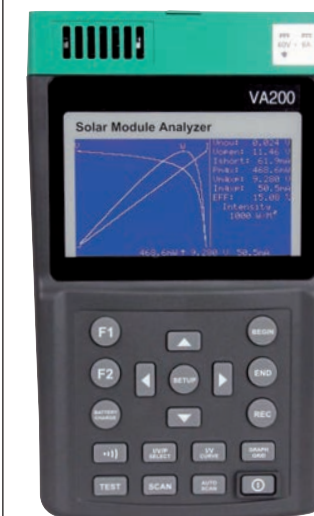

- Current/voltage graph drawing (characteristic of the solar panel)
- Autoscan search of the solar panel maximum power – Pmax (60V – 6A)
- Maximal voltage Vmaxp at Pmax power
- Maximal voltage Imaxp at Pmax power
- Opened circuit voltage Vopen
- Short-circuit opened Ishort
- I = f(V) graph with a cursor
- Efficiency calculation in %
- Power by area unit (in W/m²)
- Manual test for a particular point
- Range 10V / accuracy 0.001V
- Range 60V / accuracy 0.01V
- Range 1A / accuracy 0.1mA
- Range 6A / accuracy 1mA
- Accuracy 1% + 18dgt

Battery info: 8 x LR6

ref. VA200



Package includes:

- bag
- AC power
- accumulators
- cables connecting panels
- USB cable & software.

PYRANOMETER



The PYR1307 pyranometer measures the power of solar radiation in watts per m²: W/m²

- Ratings: 199.9 W/m² and 1,999 W/m²
- Measuring error: < 10W/m² or 5% of the reading
- Display: 2,000 pixel LCD
- Captures min. and max. values
- "Hold" key allows one to freeze the display
- Backlighting
- Supplied with a carry case
- Dimensions: 162 x 63 x 28mm
- Weight: 250g

Battery info: 2 x LR03

ref. PYR1307

LEADS FOR SOLAR PANELS

1 meter cable to connect your solar panels to all security Ø4mm terminals solution up to 20A.

Female solar connector of M type, polarity « - », ref. RSN-100
 black cable with safety plug Ø 4mm.



Male solar connector of M type, polarity « + », ref. RSR-100
 red cable with safety plug Ø 4mm.



ECO-DISTRICT: AUTONOMOUS SOLAR LED LIGHTING

This didactic solution makes it possible to understand, in a context of sustainable development, autonomous public lighting in an eco-district. Simulates urban (road, sidewalk) or rural (bus shelter) lighting. Completely autonomous and entirely at low voltage 12Vdc, the assembly operates on solar energy thanks to a set of photovoltaic components. Indoor use (halogens attached to the frame) or outdoor, under certain conditions.

EDUCATIONAL OBJECTIVES

- Study street lighting with LEDS lamppost and solar energy.
- Commission a solar system.
- Demonstrate the ecological functioning of LED technology.
- Discover the different solar panel technologies.
- Wiring photovoltaic components
- Mechanically install public lighting.
- Perform electrical and mechanical maintenance on the lamppost.
- Identify the different electrical quantities of a solar energy production chain.
- Calculate the efficiency of the installation.
- Configure communication on a Bluetooth network.
- Configure a photovoltaic installation from a tablet or smartphone.

PROPOSED PRACTICAL WORK

- Course with theoretical labs on different solar panel technologies (Monocrystalline, Polycrystalline, amorphous), on solar radiation (Direct, Diffused and Reflected), on solar irradiation.
- Study of the positioning of solar panels for maximum efficiency.
- Mechanical fixing of the mast, the panel and the lamppost on the frame.
- Study and realization of the cabling of the solar energy chain on an isolated site.
- Reading of currents and voltages at different points of the wiring.
- Interpretation of measurements and calculation of yield.
- Calculation of the battery discharge time as a function of the load.
- Configuration of the application from a touchscreen tablet.
- Mechanical and electrical maintenance.

COMPOSITION

- 1 wheeled frame with brakes, very stable. Sized for doorways.
 - 1 monocrystalline photovoltaic panel of 90Wp fixed on an aluminum mast. The panel is adjustable for outdoor use.
 - 3 halogens to be connected to a 2P + E mains socket to simulate solar radiation for indoor use of the model.
 - 1 MPPT (Maximum Power Point Tracking) load regulation system and electronic control of the device with twilight detection and programming by voltage level directly editable from a smartphone or touchscreen tablet. A recording of voltages, currents and powers of the solar panel, battery and LEDS, in the form of data, can be retrieved by an application via a Bluetooth link (display in the form of a bar graph).
 - 1 screen connected to the regulator to retrieve information from the MPPT locally.
 - 1 solar battery 12V / 14Ah
 - 1 40W lantern equipped with latest generation ultra powerful LEDs with high light output.
 - 1 electronic LED power management device integrating a management system reduction of luminous flux and detection of people.
 - 1 set of photovoltaic fuse holders.
 - 1 surge arrester.
- Component connection made on industrial terminals to prevent component wear.



Dimensions: 710 x 800 x 2000mm. Weight: 65kg.

ref. SOL-EQ1
FREE TELEPHONE ASSISTANCE ON 05 56 89 91 07

DELIVERED WIRED
AND CONFIGURED

TEACHING RESSOURCES
STUDENTS / TEACHER



90Wp monocrystalline panel swivel for use interior with the 3 projectors supplied, outdoor with a natural solar source.



Dimensions: 710 x 800 x 2000mm. Weight: 65kg.

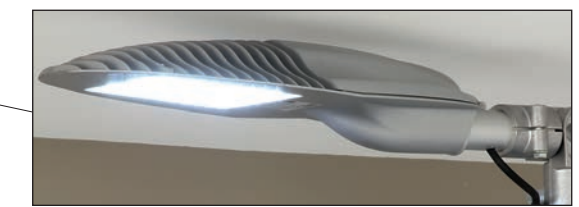

Ultra powerful LEDs with high light output

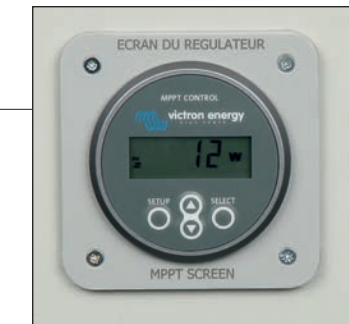

Controller screen attached to the side of the cabinet

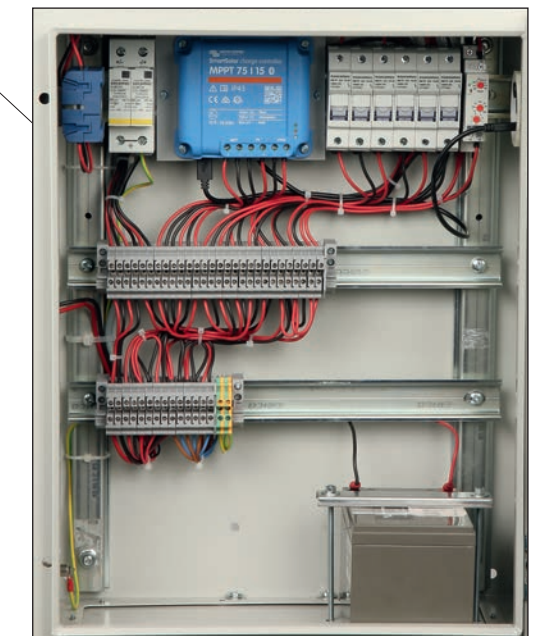

Battery box + charge regulator. Bluetooth.



Requires download from Play store or Apple store of the free Victron Energy app.

- Allows reading on tablet or smartphone:
- Voltage - Panel current / Power (W)
 - Voltage - Battery current / Load current
 - State On-Off charge

ECO-DISTRIC: PEDESTRIAN SIGNALS AND SOLAR VIDEO SURVEILLANCE

This didactic solution makes it possible to understand, in a context of sustainable development, road signs and autonomous video surveillance in an eco-district.

Simulates a pedestrian sign flashing LED light mounted on a pole with a color CCTV camera.

Autonomous and entirely in low voltage 12Vdc, the whole works on solar energy.

Indoor (halogen fixed to the frame) or outdoor use.



LED panel

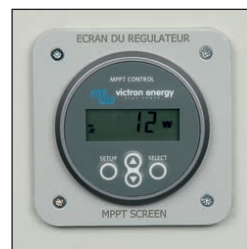

Controller screen attached to the side of the cabinet

Monocrystalline panel 30Wp swivel for indoor use with the 2 projectors supplied, outdoor with a source natural solar.



Dimensions: 710 x 800 x 1800mm. Weight: 60kg.

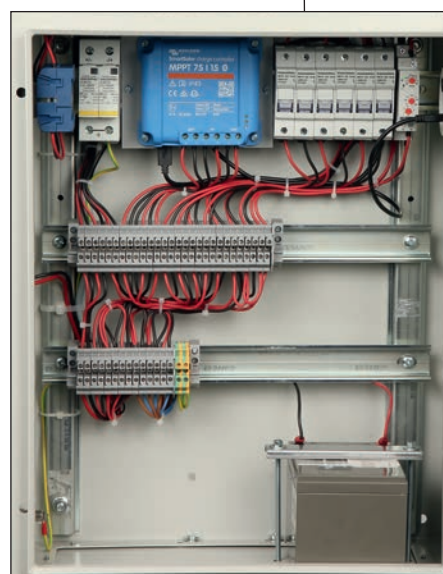

Battery box + charge regulator.

PROPOSED PRACTICAL WORK

- Course with theoretical labs on different solar panel technologies (Monocrystalline, Polycrystalline, amorphous), on solar radiation (Direct, Diffused and Reflected), on solar irradiation.
- Study of the positioning of solar panels for maximum efficiency.
- Mechanical fixing of the mast, the panel and the lamppost on the frame.
- Study and realization of the cabling of the solar energy chain on an isolated site.
- Reading of currents and voltages at different points of the wiring.
- Interpretation of measurements then calculation of yield.
- Calculation of the battery discharge time as a function of the load.
- Configuration of the application from a touchscreen tablet.
- Configuration of the Ethernet network for the use of the camera in wifi.
- Mechanical and electrical maintenance.

COMPOSITION

- 1 wheeled frame with brakes, very stable. Sized for doorways.
 - 1 pedestrian sign fitted with latest generation LEDs. Thanks to a time delay relay, the panel can blink, thus showing the energy benefit of blinking compared to a steady light.
 - 1 swiveling color camera connected to RJ45, IP protocol communication.
 - 1 monocrystalline photovoltaic panel of 30Wp fixed on an aluminum mast. The panel is adjustable for outdoor use.
 - 2 halogens to be connected to a 2P + T mains socket make it possible to simulate solar radiation for use of the model indoors.
 - 1 MPPT (Maximum Power Point Tracking) load regulation system and electronic control of the device with twilight detection and programming by voltage level directly modifiable from a smartphone or touchscreen tablet. A recording of the voltages, currents and powers of the solar panel, battery and LEDs, in the form of data, can be retrieved by an application via a Bluetooth link (display in the form of a bar graph).
 - 1 screen connected to the regulator to retrieve information from the MPPT locally.
 - 1 solar battery 12V / 14Ah
 - 1 set of photovoltaic fuse holders and 1 surge arrester.
 - 1 wifi switch
 - 1 RJ45 Ethernet cable of 3m
- Component connection made on industrial terminals to prevent component wear.



ref. SOL-EQ2

FREE TELEPHONE ASSISTANCE ON 05 56 89 91 07

DELIVERED WIRED
AND CONFIGURED

TEACHING RESSOURCES
STUDENTS / TEACHER

AUTONOMOUS
WIFI NETWORK

PEDAGOGICAL OBJECTIVES

- Study a flashing solar-powered LED sign.
- Commission a solar system.
- Demonstrate the ecological functioning of LED technology.
- Discover the different solar panel technologies.
- Wiring photovoltaic components
- Perform electrical and mechanical maintenance on the mast.
- Identify the different electrical quantities of a solar energy production chain.
- Calculate the efficiency of the installation.
- Configure communication on Bluetooth (MPPT) and wifi (camera) networks.
- Configure a photovoltaic installation using a tablet or smartphone.
- Configure an Ethernet IP network between the camera and the Wifi Switch.



Requires download from Play store or Apple store of the free Victron Energy app.

Allows reading on tablet or smartphone:

- Voltage - Panel current / Power (W)
- Voltage - Battery current / Load current
- State On-Off charge



ECO-DISTRIC: SPEED SIGNALING AND SOLAR VIDEO SURVEILLANCE

This didactic solution makes it possible to understand, in a context of sustainable development, road signs and autonomous video surveillance in an eco-district.

Simulates a 20Km / h Xenon flashing light panel mounted on a mast with a CCTV camera.

Autonomous and fully low voltage 12Vdc, all run on solar energy.

Indoor (halogen fixed to the frame) or outdoor use.

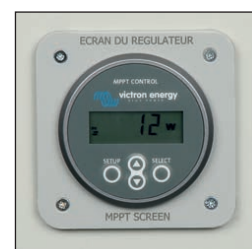

Controller screen attached to the side of the cabinet

ref. SOL-EQ3

FREE TELEPHONE ASSISTANCE ON 05 56 89 91 07

DELIVERED WIRED AND CONFIGURED

TEACHING RESSOURCES STUDENTS / TEACHER

AUTONOMOUS WIFI NETWORK



EDUCATIONAL OBJECTIVES

- Study a flashing panel and solar energy.
- Study video surveillance in urban areas powered by solar energy.
- Commission a solar system.
- Discover the different solar panel technologies.
- Wire photovoltaic components.
- Perform electrical and mechanical maintenance on the mast.
- Use hand tools.
- Identify the different electrical quantities of a solar energy production chain.
- Calculate the efficiency of the installation.
- Configure communication on a Bluetooth (MPPT) and wifi (camera) network from a tablet or Smartphone
- Configure a photovoltaic installation from a tablet or smartphone.
- Configure an Ethernet IP network, between the camera and the Wifi Switch.

PROPOSED PRACTICAL WORK

- Course on different solar panel technologies (Monocrystalline, Polycrystalline, Amorphous)
- Study on the positioning of solar panels for maximum efficiency.
- Mechanical fixing of the mast, the panel and the lamppost on the frame.
- Study of solar irradiation.
- Reminder on Direct, Diffused and Reflected solar radiation.
- Study and realization of the cabling of the solar energy chain on an isolated site.
- Reading of currents and voltages at different points of the wiring.
- Interpretation of measurements then calculation of yield.
- Calculation of the battery discharge time as a function of the load.
- Configuration of the application from a touchscreen tablet.
- Mechanical and electrical maintenance.
- Configuration of the Ethernet network, in view of the use of the camera in wifi



Dim : 710 x 800 x 1800mm. Weight: 60kg.



30Wp monocrystalline panel swivel for use interior with the 2 projectors supplied, outdoor with a natural solar source.

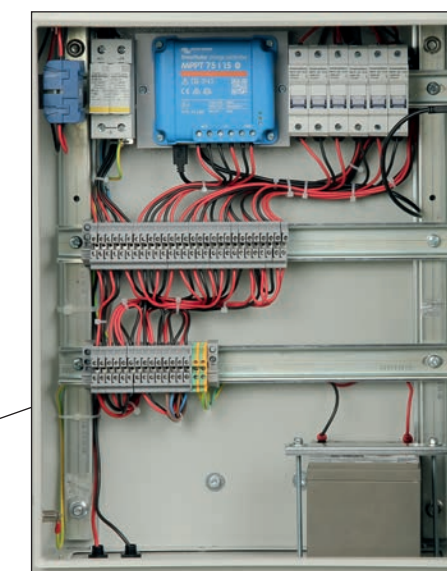

Battery box + charge regulator.

COMPOSITION

- 1 frame with wheels, very stable, passes easily between the doorways.
 - 1 traffic sign 20Km / h.
 - 2 flashing Xenon flashes.
 - 1 orientable camera connected in RJ45, communication protocol IP.
 - 1 monocrystalline photovoltaic panel of 30Wp fixed on an aluminum mast. The panel is adjustable. Allows outdoor use in good weather.
 - 2 halogens to be connected to a 2P + T mains socket make it possible to simulate solar radiation for indoor use of the model.
 - 1 MPPT (Maximum Power Point Tracking) load regulation system and electronic control of the device with twilight detection and programming by voltage level directly modifiable from a smartphone or touchscreen tablet. A recording of the voltages, currents and powers of the solar panel, battery and LEDs, in the form of data, can be retrieved by an application via a Bluetooth link (display in the form of a bar graph).
 - 1 screen connected to the regulator makes it possible to retrieve information from the MPPT locally.
 - 1 solar battery 12V / 14Ah.
 - 1 set of photovoltaic fuse holders.
 - 1 surge arrester.
 - 1 wifi switch
 - 1 RJ45 Ethernet cable of 3m
- Component connection made on industrial terminals to prevent component wear.



Requires download from Play store or Apple store of the free Victron Energy app.

Allows reading on tablet or smartphone:

- Voltage - Panel current / Power (W)
- Voltage - Battery current / Load current
- State On-Off charge



ECO-DISTRICT: SOLAR LIGHTING FOR GREEN AREAS AND CYCLE LANES

This didactic solution makes it possible to understand, in a context of sustainable development, the urban lighting of a park located in an eco-district.

Simulates the lighting of a footpath and a bicycle path.

Autonomous and fully low voltage 12Vdc, all run on solar energy.

Indoor (halogen fixed to the frame) or outdoor use.

ref. SOL-EQ4

FREE TELEPHONE ASSISTANCE ON 05 56 89 91 07

DELIVERED WIRED
AND CONFIGURED

TEACHING RESSOURCES
STUDENTS / TEACHER



EDUCATIONAL OBJECTIVES

- Commission a solar system.
- Discover the different solar panel technologies.
- Wire photovoltaic components.
- Perform electrical and mechanical maintenance on the lamppost.
- Identify the different electrical quantities of a solar energy production line.
- Calculate the efficiency of the installation.
- Configure communication on a Bluetooth network.
- Configure a photovoltaic installation from a tablet or smartphone.
- Study solar powered ground lighting
- Study the energy savings generated by the different sensors

PROPOSED PRACTICAL WORK

- Course on different solar panel technologies (Monocrystalline, Polycrystalline, Amorphous)
- Study on the positioning of solar panels for maximum efficiency.
- Mechanical fixing of the panel and the lamppost to the frame.
- Study of solar irradiation.
- Reminder on Direct, Diffused and Reflected solar radiation.
- Study and realization of the cabling of the solar energy chain on an isolated site.
- Reading of currents and voltages at different points of the wiring.
- Interpretation of measurements then calculation of yield.
- Calculation of the battery discharge time as a function of the load.
- Configuration of the application from a touchscreen tablet.
- Mechanical and electrical maintenance.



Controller screen
attached to the side
of the cabinet



30Wp monocrystalline panel swivel for use interior with the 2 projectors supplied, outdoor with a natural solar source.



Dim. : 710 x 800 x 1600mm. Weight: 50kg.

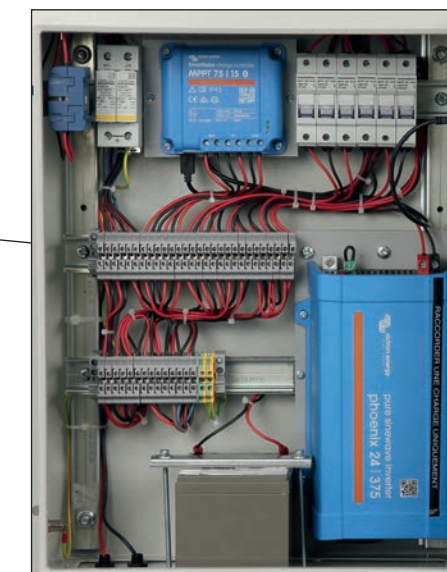

Battery box + charge regulator.

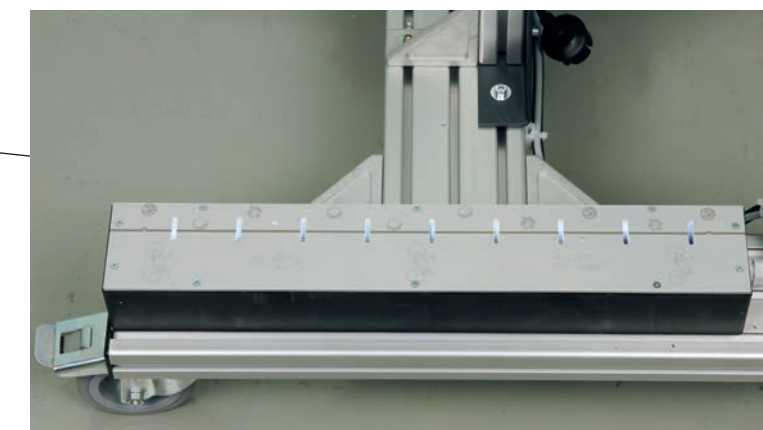

Simulation box for the lighting of a cycle lane

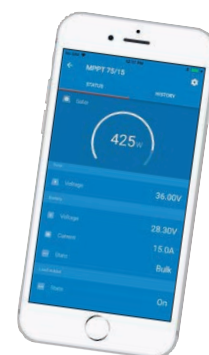

Requires download from Play store or Apple store
of the free Victron Energy app.

Allows reading on tablet or smartphone:
- Voltage - Panel current / Power (W)
- Voltage - Battery current / Load current
- State On-Off charge

COMPOSITION

- 1 frame with wheels, very stable, passes easily between the doorways.
 - Outdoor Led lighting in 230Vac.
 - A light path simulating a cycle lane.
 - 1 monocrystalline photovoltaic panel of 30Wp fixed on an aluminum mast. The panel is adjustable. Allows outdoor use in good weather.
 - 2 halogens to be connected to a 2P + T mains socket make it possible to simulate solar radiation for indoor use of the model.
 - 1 MPPT (Maximum Power Point Tracking) load regulation system and electronic control of the device with twilight detection and programming by voltage level directly modifiable from a smartphone or touchscreen tablet. A recording of the voltages, currents and powers of the solar panel, battery and LEDs, in the form of data, can be retrieved by an application via a Bluetooth link (display in the form of a bar graph).
 - A 12Vdc / 230Vac-50Hz voltage converter communicating via Bluetooth. Setting the output voltage 210-245V, the security level according to the input voltage. Viewing data such as the charge rate or the input and output voltage.
 - 1 screen connected to the regulator makes it possible to retrieve information from the MPPT locally.
 - 1 solar battery 12V / 14Ah.
 - 1 set of photovoltaic fuse holders.
 - 1 surge arrester.
- Component connection made on industrial terminals to prevent component wear.

ECO-DISTRICT: PEDESTRIAN SIGNAL, VIDEO SURVEILLANCE AND SOLAR STREET LIGHTING

This didactic solution makes it possible to understand, in a context of sustainable development, road signs, video surveillance autonomous and urban lighting in an eco-district.

Autonomous and fully low voltage 12Vdc, all run on solar energy.

Indoor (halogen fixed to the frame) or outdoor use.

ref. SOL-EQ5
FREE TELEPHONE ASSISTANCE ON 05 56 89 91 07

- DELIVERED WIRED AND CONFIGURED
- TEACHING RESSOURCES STUDENTS / TEACHER
- AUTONOMOUS WIFI NETWORK



LED panel

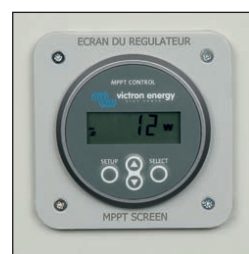

Controller screen attached to the side of the cabinet

Monocrystalline panel 90Wp swivel for indoor use with the 3 projectors supplied, outdoor with a source natural solar.



Dimensions : 710 x 800 x 2100mm. Weight 70kg.

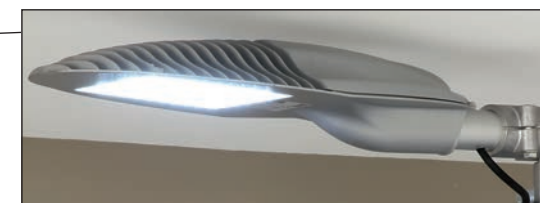

Ultra powerful LEDs with high light output

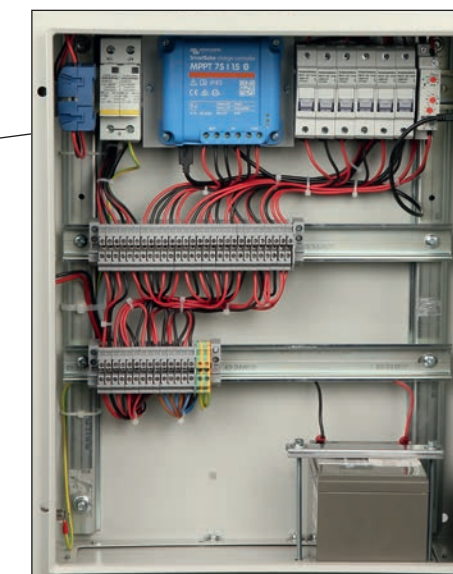

Battery box + charge regulator.

EDUCATIONAL OBJECTIVES

- Study a flashing solar-powered LED sign.
- Study street lighting with solar-powered LEDS lamppost
- Study video surveillance in urban areas powered by solar energy
- Commission a solar system.
- Demonstrate the ecological functioning of LED technology.
- Discover the different solar panel technologies.
- Wiring photovoltaic components
- Perform electrical and mechanical maintenance on the mast.
- Identify the different electrical quantities of a solar energy production chain.
- Calculate the efficiency of the installation.
- Configure communication on Bluetooth (MPPT) and wifi (camera) networks.
- Configure a photovoltaic installation using a tablet or smartphone.
- Configure an Ethernet IP network between the camera and the Wifi Switch.
- Study the energy savings generated by the different sensors

PROPOSED PRACTICAL WORK

- Course on different solar panel technologies (Monocrystalline, Polycrystalline, Amorphous)
- Study on the positioning of solar panels for maximum efficiency.
- Mechanical fixing of the mast, the panel and the lamppost on the frame.
- Study of solar irradiation.
- Reminder on Direct, Diffused and Reflected solar radiation.
- Study and realization of the cabling of the solar energy chain on an isolated site.
- Read the currents and voltages at different points of the wiring.
- Interpret the measurements and then calculate the yield.
- Calculation of the battery discharge time as a function of the load.
- Configuration of the application from a touchscreen tablet.
- Mechanical and electrical maintenance.
- Configuration of the application from a touchscreen tablet.
- Mechanical and electrical maintenance.

COMPOSITION

- 1 wheeled frame with brakes, very stable. Sized for doorways.
 - 1 pedestrian sign fitted with latest generation LEDs. Thanks to a time delay relay, the panel can blink, thus showing the energy benefit of blinking compared to a steady light.
 - A 40W lantern equipped with latest generation ultra powerful LEDs with high light output.
 - 1 swiveling color camera connected to RJ45, IP protocol communication.
 - 1 monocrystalline photovoltaic panel of 90Wp fixed on an aluminum mast.
 - The panel is adjustable for outdoor use.
 - 3 halogens to be connected to a 2P + T mains socket make it possible to simulate solar radiation for use of the model indoors.
 - 1 MPPT (Maximum Power Point Tracking) load regulation system and electronic control of the device with twilight detection and programming by voltage level directly modifiable from a smartphone or touchscreen tablet. A recording of the voltages, currents and powers of the solar panel, battery and LEDS, in the form of data, can be retrieved by an application via a Bluetooth link (display in the form of a bar graph).
 - 1 screen connected to the regulator to retrieve information from the MPPT locally.
 - 1 solar battery 12V / 14Ah
 - 1 set of photovoltaic fuse holders and 1 surge arrester.
 - 1 wifi switch
 - 1 RJ45 Ethernet cable of 3m
- Component connection made on industrial terminals to prevent component wear.



Requires download from Play store or Apple store of the free Victron Energy app.

- Allows reading on tablet or smartphone:
- Voltage - Panel current / Power (W)
 - Voltage - Battery current / Load current
 - State On-Off charge

ECO-DISTRICT: ELECTRIC VEHICLE CHARGING STATION WITH SOLAR LIGHTING

This didactic solution makes it possible to understand, in a context of sustainable development, electric vehicle charging stations located in an eco-district. This application is a charging station controlled by code keypad or badges, illuminated by a solar and autonomous porthole.

The power part of the charging station is 230Vac, generated by the voltage converter from the energy stored in the batteries, protected by a differential circuit breaker with key authorization for switching on. The lighting part is in low voltage 12Vdc.

Indoor (halogen fixed to the frame) or outdoor use.

ref. SOL-EQ6

FREE TELEPHONE ASSISTANCE ON 05 56 89 91 07

DELIVERED WIRED
AND CONFIGURED

TEACHING RESSOURCES
STUDENTS / TEACHER

AUTONOMOUS
WIFI NETWORK



EDUCATIONAL OBJECTIVES

- Study a charging station and solar energy lighting
- Demonstrate the ecological functioning of a hybrid terminal
- Study the different types of charging sockets for electric vehicles
- Test an electric vehicle charging station.
- Study an access command by code keypad and RFID badge
- Commission a solar system.
- Discover the different solar panel technologies.
- Wiring photovoltaic components
- Perform electrical and mechanical maintenance on the mast.
- Identify the different electrical quantities of a solar energy production chain.
- Calculate the efficiency of the installation.
- Configure communication on a Bluetooth (MPPT) and wifi network (charging station).
- Configure a photovoltaic installation using a tablet or smartphone.
- Configure an Ethernet IP network between the camera and the Wifi Switch.
- Study the energy savings generated by the different sensors

PROPOSED PRACTICAL WORK

- Wiring of a charging station control circuit
- Configuration of the charging station in wifi thanks to the Webservice integrated in the station (visualization of operating status, configuration of the communication kit, choice of charging mode, time programming, history, intensity adjustment, locking, charging stop...)
- Configuration of the RFID keyboard (choice of operation by code, RFID badges, code + RFID badges)
- Calculation of the battery discharge time as a function of the load.
- Reading of currents and voltages at different points of the wiring.
- Interpretation of measurements and calculation of yield.
- Study on the positioning of solar panels for maximum efficiency.
- Course on different solar panel technologies (Monocrystalline, Polycrystalline, Amorphous)
- Study of solar irradiation.
- Reminder on Direct, Diffused and Reflected solar radiation.
- Configuration of the application from a touchscreen tablet.
- Mechanical fixing of the bollard, panel and lamppost on the frame.
- Mechanical and electrical maintenance.



Controller screen attached to the side of the cabinet

Monocrystalline panel 90Wp swivel for indoor use with the 3 projectors supplied, outdoor with a source natural solar.



Dimensions : 710 x 1100 x 1900mm. Weight 70kg.



Requires download from Play store or Apple store of the free Victron Energy app.

Allows reading on tablet or smartphone:

- Voltage - Panel current / Power (W)
- Voltage - Battery current / Load current
- State On-Off charge

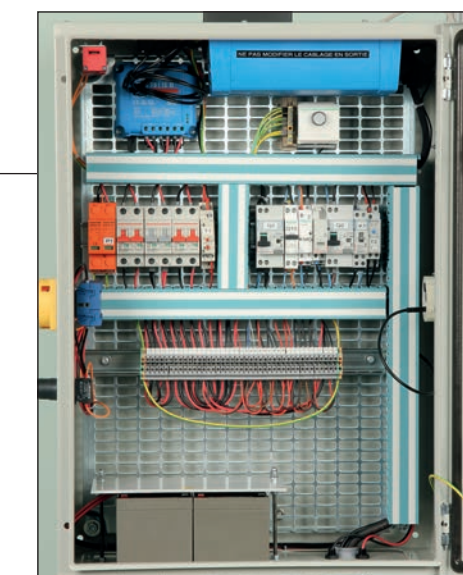
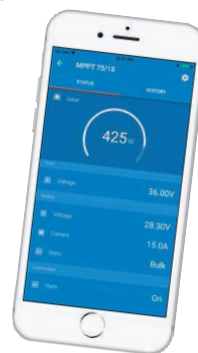

Battery box + charge regulator.



Delivered with a tester charging station

COMPOSITION

- 1 wheeled frame with brakes, very stable. Sized for doorways.
- 1 single-phase 3.7 kW to 4.5 kW electric charging station (one mode 3 type 2 socket). Integrated web server allowing the terminal to be configured via the Wifi switch or operation by the user via Bluetooth. Application to download for free from Play Store® or Apple Store®
- 1 power supply box with protections and operating authorization by key.
- 1 charging station tester
- 1 code keypad (3 operating modes by RFID badge, by code, by RFID badge + code)
- 1 12Vdc lighting
- 1 presence detector
- 1 monocrystalline photovoltaic panel of 90Wp fixed on an aluminum mast. The panel is adjustable for outdoor use.
- 3 halogens to be connected to a 2P + T mains socket make it possible to simulate solar radiation for use of the model indoors.
- 1 MPPT (Maximum Power Point Tracking) load regulation system and electronic control of the device with twilight detection and programming by voltage level directly modifiable from a smartphone or touchscreen tablet. A recording of the voltages, currents and powers of the solar panel, battery and LEDs, in the form of data, can be retrieved by an application via a Bluetooth link (display in the form of a bar graph).
- 1 screen connected to the regulator to retrieve information from the MPPT locally.
- 2 solar batteries 12V / 14Ah
- 1 set of photovoltaic circuit-breakers and 1 surge arrester.
- 1 wifi switch
- 1 RJ45 Ethernet cable of 3m

Component connection made on industrial terminals to prevent component wear.

ECO-DISTRICT: AUTONOMOUS SOLAR VIDEO SURVEILLANCE

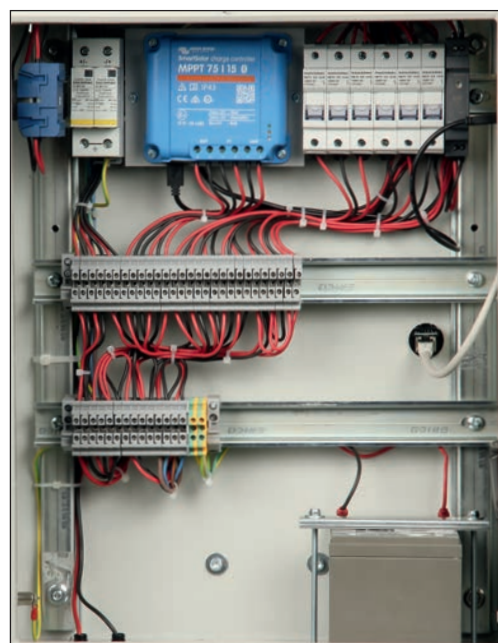

Battery box + charge regulator. Bluetooth.



Monocrystalline panel 30Wp swivel for indoor use with the 2 projectors supplied, outdoor with a source natural solar.

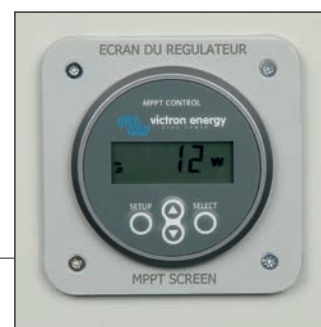

Controller screen attached to the side of the cabinet

Dimensions : 710 x 800 x 1900mm. Weight: 55kg.

ref. SOL-EQ7

FREE TELEPHONE ASSISTANCE ON 05 56 89 91 07

DELIVERED WIRED AND CONFIGURED

TEACHING RESSOURCES STUDENTS / TEACHER

AUTONOMOUS WIFI NETWORK



 **Bluetooth®**

Requires download from Play store or Apple store of the free Victron Energy app.

Allows reading on tablet or smartphone:

- Voltage - Panel current / Power (W)
- Voltage - Battery current / Load current
- State On-Off charge

This didactic solution makes it possible to understand, in a context of sustainable development, an autonomous CCTV camera in an eco-district.

Completely autonomous and entirely at low voltage 12Vdc, the assembly operates on solar energy thanks to a set of photovoltaic components. Indoor use (halogens attached to the frame) or outdoor, under certain conditions.

EDUCATIONAL OBJECTIVES

- Study video surveillance in urban areas powered by solar energy
- Commission a solar system.
- Discover the different solar panel technologies.
- Wiring photovoltaic components
- Perform electrical and mechanical maintenance on the mast.
- Identify the different electrical quantities of a solar energy production chain.
- Calculate the efficiency of the installation.
- Configure communication on a Bluetooth and Wifi network.
- Configure an Ethernet IP network between the camera and the Wifi Switch
- Configure a photovoltaic installation from a tablet or smartphone.

PROPOSED PRACTICAL WORK

- Course with theoretical labs on different solar panel technologies (Monocrystalline, Polycrystalline, amorphous), on solar radiation (Direct, Diffused and Reflected), on solar irradiation.
- Study of the positioning of solar panels for maximum efficiency.
- Mechanical fixing of the mast on the frame.
- Study and realization of the cabling of the solar energy chain on an isolated site.
- Reading of currents and voltages at different points of the wiring.
- Interpretation of measurements and calculation of yield.
- Calculation of the battery discharge time as a function of the load.
- Configuration of the application from a touchscreen tablet.
- Mechanical and electrical maintenance.

COMPOSITION

- 1 wheeled frame with brakes, very stable. Sized for doorways.
 - A swiveling color camera connected to RJ45, IP protocol communication.
 - 1 monocrystalline photovoltaic panel of 30Wp fixed on an aluminum mast. The panel is adjustable for outdoor use.
 - 2 halogens to be connected to a 2P + E mains socket to simulate solar radiation for indoor use of the model.
 - 1 MPPT (Maximum Power Point Tracking) load regulation system and electronic control of the device with twilight detection and programming by voltage level directly editable from a smartphone or touchscreen tablet. A recording of voltages, currents and powers of the solar panel, battery and LEDs, in the form of data, can be retrieved by an application via a Bluetooth link (display in the form of a bar graph).
 - 1 screen connected to the regulator to retrieve information from the MPPT locally.
 - 1 solar battery 12V / 14Ah
 - 1 set of photovoltaic fuse holders.
 - 1 surge arrester.
 - A wifi switch
 - 1 RJ45 Ethernet cable of 3m
- Component connection made on industrial terminals to prevent component wear.

ECO-DISTRICT: AUTONOMOUS SOLAR VIDEO SURVEILLANCE WITH ASSISTED VIDEO PROTECTION

This didactic solution makes it possible to understand, in a context of sustainable development, a set of CCTV cameras (including one motorized) in an eco-district. Video surveillance is accompanied by a recorder with screen simulating a security post. Completely autonomous and entirely at low voltage 12Vdc, the assembly operates on solar energy thanks to a set of photovoltaic components. Indoor use (halogens attached to the frame) or outdoor, under certain conditions.

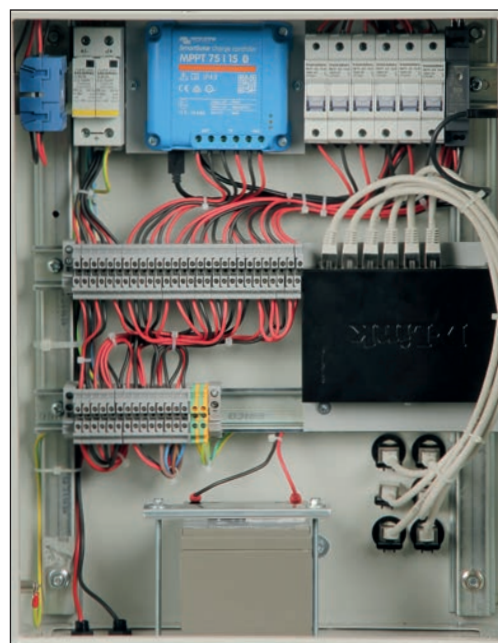

Interior view of the electrical cabinet



Dimensions : 710 x 800 x 1900mm. Weight: 55kg.

ref. SOL-EQ8

FREE TELEPHONE ASSISTANCE ON 05 56 89 91 07

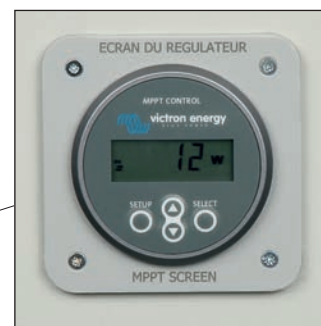
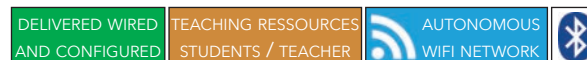

Ecran du régulateur fixé sur le côté de l'armoire



Connectique RJ45

30Wp monocrystalline panel swivel and swivel for use interior with the 2 projectors supplied, outdoor with a natural solar source.



Supplied with an 18 "HD LED recorder and monitor representing the security post.



 **Bluetooth®**

Requires download from Play store or Apple store of the free Victron Energy app.

Allows reading on tablet or smartphone:
 - Voltage - Panel current / Power (W)
 - Voltage - Battery current / Load current
 - State On-Off charge

EDUCATIONAL OBJECTIVES

- Study video surveillance in urban areas powered by solar energy
- Carry out the configuration of the dome camera
- Carry out the recording settings
- Commission a solar system.
- Discover the different solar panel technologies.
- Wiring photovoltaic components
- Perform electrical and mechanical maintenance on the mast.
- Identify the different electrical quantities of a solar energy production chain.
- Configure a photovoltaic installation from a tablet or smartphone.
- Calculate the efficiency of the installation.
- Configure communication on a Bluetooth and Wifi network.
- Configure an Ethernet IP network between the camera and the Wifi Switch

PROPOSED PRACTICAL WORK

- Course with theoretical labs on different solar panel technologies (Monocrystalline, Polycrystalline, amorphous), on solar radiation (Direct, Diffused and Reflected), on solar irradiation.
- Configuration and control of the dome camera
- Viewing a recording made by surveillance cameras
- Study of the positioning of solar panels for maximum efficiency.
- Mechanical fixing of the mast to the frame.
- Study and realization of the cabling of the solar energy chain on an isolated site.
- Reading of currents and voltages at different points of the wiring.
- Interpretation of measurements and calculation of yield.
- Calculation of the battery discharge time as a function of the load.
- Configuration of the application from a touchscreen tablet.
- Mechanical and electrical maintenance.

COMPOSITION

- 1 wheeled frame with brakes, very stable. Sized for doorways.
 - 2 orientable color cameras connected in RJ45, IP protocol communication
 - 1 All-in-one color Day / Night PTZ dome camera, 20x optical zoom, FULL-HD resolution (1080p) @ 30 fps, 4 "waterproof IP66 casing, infrared LEDs with operating distance up to 150 meters (Smart IR) Controlled by mouse, smartphone or tablet.
 - 1 XVR AHD video recorder, 8 analog video inputs and 3 IP video inputs. HDD 1TB special video surveillance. Integrated web server for configuration and video playback. Simultaneous viewing of camera images on the monitor.
 - 1 18 "LED monitor. HD resolution.
 - 1 optical mouse
 - 1 monocrystalline photovoltaic panel of 30Wp fixed on an aluminum mast. The panel is adjustable for outdoor use.
 - 2 halogens to be connected to a 2P + E mains socket to simulate solar radiation for indoor use of the model.
 - 1 MPPT (Maximum Power Point Tracking) load regulation system and electronic control of the device with twilight detection and programming by voltage level directly modifiable from a smartphone or touchscreen tablet. A recording of the voltages, currents and powers of the solar panel, battery and LEDs, in the form of data, can be retrieved by an application via a Bluetooth link (display in the form of a bar graph).
 - 1 screen connected to the regulator to retrieve information from the MPPT locally.
 - 1 solar battery 12V / 14Ah
 - 1 set of photovoltaic fuse holders.
 - 1 surge arrester.
 - A wifi switch
 - 1 RJ45 Ethernet cable of 3m
- Component connection made on industrial terminals to prevent component wear.



www.merazet.pl

Dystrybutor na rynek Polski

MERAZET Spółka Akcyjna

ul. J. Krauthofera 36

60-203 Poznań

tel. +48 61 8644 610

tel. +48 61 8644 630