

True RMS Digital Multimeters

EX360 Series

EX360 True RMS Digital Multimeter

EX363 True RMS DMM with Temperature and μ A AC/DC

EX365 True RMS DMM with 10A AC/DC Current

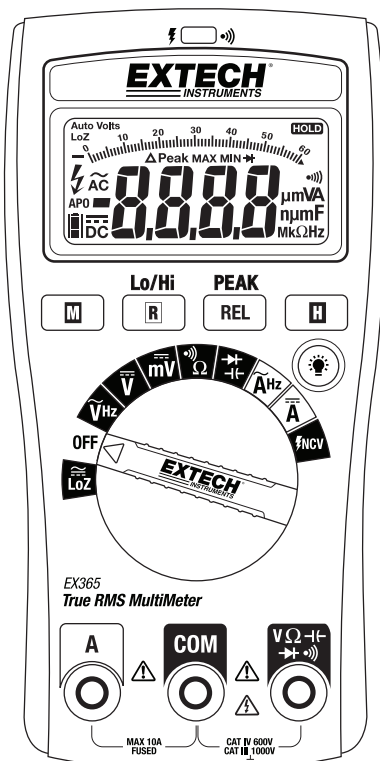

Table of Contents

1. INTRODUCTION	3
2. SAFETY INFORMATION	4
3. DESCRIPTIONS	6
4. OPERATION	9
Powering the Meter	9
Disable Auto Power OFF	9
Display Backlight	9
Smart Data Hold	9
Test Lead Considerations	9
Voltage Measurements	10
Lo Z Voltage Measurements	12
PEAK MAX-MIN HOLD Mode (AC only)	12
10A AC/DC Current Measurements (EX365 only)	13
µA AC/DC Current Measurements (EX363 only)	14
Non-Contact Voltage Detector	15
Resistance Measurements	16
Continuity Measurements	16
Capacitance Measurements	17
Relative Mode	17
Diode Test	18
Temperature Measurements (EX363 only)	19
5. MAINTENANCE	20
6. SPECIFICATIONS	22

1. Introduction

Thank you for selecting the Extech EX360 Series Meter.

The EX360 Series are feature-packed True RMS digital multimeters. In addition to standard DMM features, they offer a Low Impedance (Lo Z) mode, Smart Data Hold, Automatic AC/DC voltage Detect mode, Backlit LCD, and a Non-Contact Voltage Detector that senses electrical sources safely.

This device is shipped fully tested and calibrated and, with proper use, will provide years of reliable service. Please visit our website (www.extech.com) to check for the latest version of this User Guide, Product Updates, Product Registration, and Customer Support.

Features

- 6000 count digital display and 60 segment analog bar graph display
- Large backlit LED display
- True RMS ACV measurements
- Lo Z mode (with Auto AC/DC Voltage detect) protects readings from ghost voltages
- Auto and Manual Range modes
- 0.5% DCV accuracy
- Smart Data Hold
- Peak Hold
- Relative mode
- Auto Power OFF (APO) with disable function
- Temperature measurements (Model EX363 only) with included temperature probe
- AC/DC μ A function (Model EX363 only)
- 10A AC/DC current measurements with 11A/1000V high energy fuse (EX365 only)
- Non-Contact Voltage Detector
- Visual and audible continuity measurement alert
- Segmented low battery indicator
- Includes holster with probe holder, tilt stand, type K temperature probe (EX363), magnetic hanger, and 9V battery.
- CAT IV 600V / CAT III 1000V

2. Safety Information

To ensure the safe operation and service of the meter, follow these instructions closely. Failure to observe warnings can result in severe injury.



WARNINGS

WARNINGS identify hazardous conditions and actions that could cause BODILY HARM or DEATH.

- When handling test leads or probes, keep hands and fingers behind the finger guards at all times.
- Remove test leads from the meter before opening the battery compartment or meter housing.
- Use the meter only as specified in this User Guide or accompanying Quick Start to avoid compromising the protections provided by the meter.
- Be sure to use the proper terminals, switch positions, and ranges when taking measurements.
- Verify the meter's operation by measuring a known voltage. Have the meter serviced if the meter responds unusually or if there are questions regarding the meter's functional integrity.
- Do not apply more than the rated voltage, as marked on the meter, between terminals or between any terminal and earth ground.
- Replace blown fuses with fuses of the same type and rating as specified in this User Guide.
- Use caution working with voltages above 30 VAC RMS, 42 VAC peak, or 60 VDC. These voltages pose a shock hazard.
- To avoid misleading readings that could lead to electric shock and injury, replace the batteries as soon as the low battery indicator is displayed.
- Disconnect power to the circuit under test and discharge all high-voltage capacitors before testing resistance, continuity, diodes, or capacitance.
- Do not use the meter in the presence of explosive gas or vapor.
- To reduce risk of fire or electric shock, do not use the meter if it is wet and do not expose the meter to moisture.
- Individual protective equipment should be used if HAZARDOUS LIVE parts in the installation where measurements are to be carried out could be accessible.













CAUTIONS

CAUTIONS identify conditions and actions that could cause DAMAGE to the meter or equipment under test. Do not expose the meter to extremes in temperature or high humidity.

- Disconnect the test leads from the test points before changing the position of the function (rotary) switch.
- Do not expose the meter to extremes in temperature or to high humidity.
- Never set the meter to the resistance, diode, capacitance, micro-amp, or amp functions when measuring the voltage of a power supply circuit; this could result in meter damage and damage to the equipment under test.

Safety Symbols that are typically marked on meters and instructions

	This symbol, adjacent to another symbol, indicates the user must refer to the manual or user guide for further information.
	Risk of electrical shock
	Fuse symbol
	Equipment protected by double or reinforced insulation
	Battery symbol
	Conforms to EU directives
	Do not discard this product in household trash.
	AC measurement
	DC measurement
	Earth ground

Unsafe Voltage Alert

When the meter detects a voltage equal to or greater than 30V or a voltage overload (OL) in V, mV, or Lo Z mode, the symbol  is displayed. This system was designed to alert the user of a potentially hazardous voltage.

PER IEC1010 OVERVOLTAGE INSTALLATION CATEGORY

OVERVOLTAGE CATEGORY I

Equipment of OVERVOLTAGE CATEGORY I is equipment for connection to circuits in which measures are taken to limit the transient over-voltages to an appropriate low level.

Note – Examples include protected electronic circuits.

OVERVOLTAGE CATEGORY II

Equipment of OVERVOLTAGE CATEGORY II is energy-consuming equipment to be supplied from the fixed installation.

Note – Examples include household, office, and laboratory appliances.

OVERVOLTAGE CATEGORY III

Equipment of OVERVOLTAGE CATEGORY III is equipment in fixed installations.

Note – Examples include switches in the fixed installation and some equipment for industrial use with permanent connection to the fixed installation.

OVERVOLTAGE CATEGORY IV

Equipment of OVERVOLTAGE CATEGORY IV is for use at the origin of the installation.

Note – Examples include electricity meters and primary over-current protection equipment

3. Descriptions

Meter Description (EX365 pictured)

1. Non-Contact Voltage Detector and Continuity alert light
2. LCD multi-function display
3. **M** (MODE) button (also °C/°F button on EX363)
4. **R RANGE** and **Lo/Hi** button
5. Rotary function select switch
6. Positive input terminal (10A Current) for EX365 only
7. Common (-) input terminal
8. Positive input terminal: Voltage, Resistance, Capacitance, Temperature (EX363), and μA (EX363)
9. LCD Backlight button
10. **H** Data Hold button
11. **PEAK MAX-MIN / Δ REL (RELATIVE)** button
12. Battery compartment on back of meter

Fig 3-1 METER DESCRIPTION

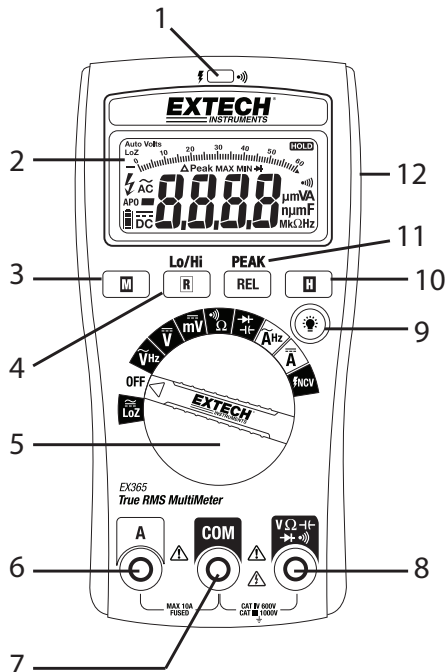

Display Icon Descriptions

- **Auto Volts**: Automatic AC/DC voltage detect (for **Lo Z** mode only)
- **Auto**: Automatic range mode
- **HOLD**: Display hold
- **Lo Z**: Low Impedance mode
- Δ : Relative mode
- \sim and **AC**: Alternating Current Measurements
- --- and **DC**: Direct Current Measurements
- 8888 : Main display digits
- ||||| : Bar graph
- **A**: Amperes (Current)
- **V**: Volts (Voltage)
- $^{\circ}\text{C}/^{\circ}\text{F}$: Temperature units
- **F**: Farads (Capacitance measurement units)
- **Hz**: Hertz (Frequency measurements unit)
- Ω (Ohms): Resistance measurement unit
- ||||| : Battery status icon
- - Minus (negative) sign
- ⚡ : Non-Contact Volt Detect and high voltage icon
- **PEAK MAX-MIN** Peak Maximum and Minimum reading memory
- ▶ : Diode measurement mode
-))) : Continuity mode symbol
- Prefixes: μ (micro: 10^{-6}), m (milli: 10^{-3}), n (nano: 10^{-9}), k (kilo: 10^3), M (mega: 10^6)

Fig 3-2 METER DISPLAY

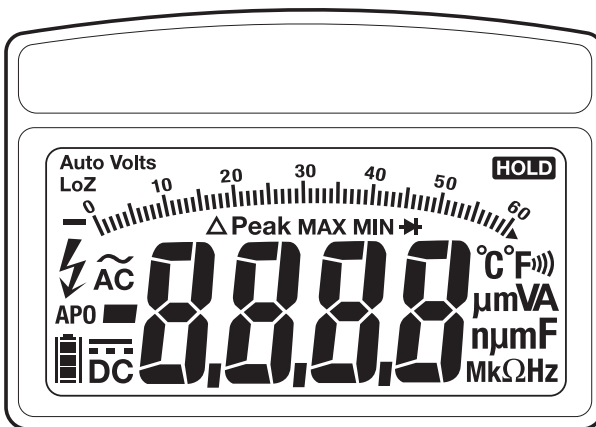

Push-Button Descriptions

°C/°F

M

Press the **M** (MODE) button to perform the following. The °C/°F function is only available on the EX363 model:

Switch Position	MODE (M) Button Function
\tilde{V}	V \longleftrightarrow Hz
\tilde{A} (EX365)	A \longleftrightarrow Hz
Ω	Ω \longleftrightarrow)))
$\overleftarrow{\leftarrow}$	$\overleftarrow{\leftarrow}$ \longleftrightarrow $\overrightarrow{\rightarrow}$
μA (EX363)	AC \longleftrightarrow DC
TEMP (EX363)	°C \longleftrightarrow °F

Lo/Hi

R

Press **R** (Range) to switch from Auto to Manual Range. Hold to return to Auto Range. Press to select Non-Contact Voltage Detector Sensitivity **Lo** (low) or **Hi** (high).

PEAK

REL

Short press activates Relative Δ mode; long press access/exit PEAK MAX-MIN mode.

□

Press to turn Smart Data Hold ON or OFF.



Press to turn the LCD backlight ON or OFF

4. Operation



CAUTION: Read and understand all of the Safety statements listed in the safety section of this manual prior to use.

Powering the Meter

1. Turn the rotary function switch to any position to power the meter. Check the batteries if the unit fails to power ON. Refer to the Maintenance section for battery and fuse replacements.
2. Turn the function switch to the OFF position to power OFF the meter.
3. The meter has an Auto Power OFF feature (APO) where the meter switches OFF after 20 minutes of inactivity. When APO is enabled, the APO icon will show on the display when the meter is powered ON. To disable APO, refer to the next section.

Note: The meter displays the battery capacity when powering up. The display will either show the word FULL (battery fully charged) or a percentage representing remaining battery power. The international segmented battery strength symbol  is also shown on the display at all times when the meter is ON and when there is sufficient battery power to power the meter.

Disable Auto Power OFF

The meter will auto power OFF after 20 minutes of inactivity. To defeat this feature, follow the steps below.

1. With the meter OFF, press and hold the **M** (MODE) button and, while continuing to hold, turn the rotary function switch to any position to power ON the meter.
2. The display will show **AOFF**.
3. Release the button.
4. APO will now be disabled until the next cycle of power.

Display Backlight

With the meter powered ON, press the backlight button  to switch the backlight ON or OFF. Note that excessive use of the backlight will shorten the battery life.

Smart Data Hold

To freeze the LCD meter reading, press the **H** (HOLD) button. While data hold is active, the **HOLD** display icon appears on the LCD. Press the **H** button to return to normal operation. The **HOLD** icon will switch OFF.

The meter's beeper will sound and the LCD will flash if the detected signal is 50 counts greater than the held reading.

Test Lead Considerations

Test lead probe covers can be removed for CAT II 1000V installations. Use the test lead probe covers for CAT III 1000V or CAT IV 600V installations. Do not measure voltages > 1000V AC or DC. Remove the storage caps from the meter end of test leads before connecting leads to the meter.

Voltage Measurements



WARNING: Remove the test lead probe covers for CAT II 1000V installations. Use the test lead probe covers for CAT III 1000V or CAT IV 600V installations. Do not measure voltages greater than 1000V.



CAUTION: When connecting the test leads to the circuit or device under test, connect the black lead before the red; when removing the test leads, remove the red before the black lead.

AC Voltage Measurements

1. Insert the black test lead banana plug into the negative (COM) jack and the red test lead banana plug into the positive (V/Ω) jack.
2. Turn the function switch to the \tilde{V} position.
3. The meter defaults to the Auto Range mode (Auto displayed on LCD). Press the **R** button to access the manual range mode. Press and hold the **R** button to return to the Auto Range mode (**Auto** will be displayed).
4. Read the Warning and Caution statements above to determine whether or not to use the test lead probe covers.
5. Touch the test probe tips to the circuit under test.
6. Read the digital value and the bar graph representation of the measurement in the display. The display will also indicate the proper decimal point and measurement type/units symbols.
7. Note the voltage alert symbol ⚡ when voltage is present.
8. Use the **M** button to view the frequency (Hz) of the measured voltage.

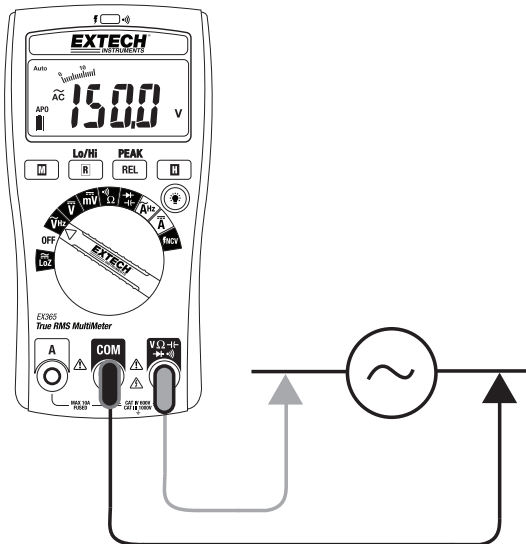

Fig 4-1 AC VOLTAGE MEASUREMENTS

DC Voltage Measurements

1. Insert the black test lead banana plug into the negative (COM) jack and the red test lead banana plug into the positive (V/ Ω) jack.
2. Move the Function Switch to the \overline{V} or $m\overline{V}$ position.
3. Read the Warning and Caution statements at the beginning of this section to determine whether or not to use the test lead probe covers.
4. Touch the test probe tips to the circuit under test. Be sure to observe the correct polarity (red lead to positive, black lead to negative).
5. The meter defaults to the Auto Range mode (**Auto** displayed on LCD). Press the **R** button to access the manual range mode. Press and hold the **R** button to return to the Auto Range mode.
6. Read the digital value and the bar graph representation of the measurement in the display. The display will also indicate the proper decimal point and measurement type/units symbols. If the polarity is reversed, the display will show (-) minus before the value.
7. Note the voltage alert symbol ⚡ when voltage is present.
8. The meter is capable of detecting DC voltages to 1000V.

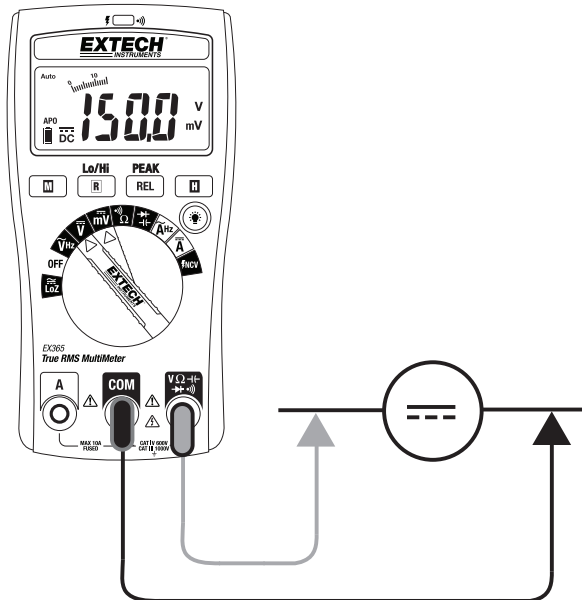





Fig 4-2 DC VOLTAGE MEASUREMENTS

Lo Z Voltage Measurements

When the function switch is turned to the **Lo Z**  position, the meter incorporates an automatic voltage detection circuit to automatically determine voltage AC or DC and a low Z (impedance) circuit* that eliminates ghost voltage complications. Refer to the Voltage Measurements section earlier in this guide for Safety information and connection diagrams.

**The Lo Z impedance is approx. 3kΩ increasing to over 100kΩ when measuring 1000V.*

1. Insert the black test lead banana plug into the negative (COM) jack and the red test lead banana plug into the positive (V/Ω) jack.
2. Move the Function Switch to the **Lo Z**  position.
3. Touch the test probe tips to the circuit under test. Be sure to observe the correct polarity (red lead to positive, black lead to negative).
4. The meter defaults to the Auto Range mode (Auto displayed on LCD). Manual range cannot be used in this mode.
5. Read the digital value and the bar graph representation of the measurement in the display. The display will also indicate the proper decimal point and measurement type/units symbols. If the polarity is reversed, the display will show (-) minus before the value.
6. The meter is capable of detecting AC/DC voltages to 1000V.
7. Note the voltage alert symbol  when voltage is present.

PEAK MAX-MIN HOLD Mode (AC only)

In the PEAK HOLD mode the meter records MAX and MIN measurement values. When the measurement exceeds a recorded MAX or MIN value, the meter replaces the existing value with the newer value.

1. Press and hold the **PEAK** button for at least two seconds. **PEAK MAX MIN** will be displayed and the meter will begin recording MAX and MIN values.
2. A short press of the **PEAK** button will show the MAX recorded reading.
3. Another short press of the **PEAK** button will show the MIN recorded reading.
4. Press the **PEAK** button again to view real time readings while MAX MIN recording continues in the background.
5. To pause MAX MIN recording, press the **H** button. The display will freeze and the HOLD icon will appear. Press **H** again to return to real time readings (with MAX MIN recording continuing in the background)
6. To exit the PEAK HOLD MAX MIN mode, press and hold the **PEAK** button for > 2 seconds. The meter will return to normal operation and the PEAK MAX MIN icons will switch OFF.

10A AC/DC Current Measurements (EX365 only)



WARNING: Do not handle the test leads above the finger/hand guard barrier.



CAUTION: Observe CAT III 1000V CAT IV 600V with respect to Earth Ground.

1. Insert the black test lead into the **COM** terminal and the red test lead into the **A** terminal.
2. Turn the meter's function switch to the \tilde{A} or \bar{A} position. The **A** symbol will appear on the display indicating Amperes (Amps).
3. The meter defaults to the Auto Range mode. When in Auto mode, the display shows the **Auto** icon in the upper left corner. Use the **R** button to manually range the meter. Press and hold the **R** button to return to the Auto Range mode.
4. The meter display will show **AC** or **DC** depending on the function switch position.
5. Current measurements must be taken in series with the circuit under test. See accompanying diagram.
6. Touch the black test lead to the negative side of the circuit and the red test lead to the positive side of the circuit.
7. Read the current measurement in the display represented by numerical digits and bar graph. The display will indicate the proper decimal point and value. In DC, If the polarity is reversed, the display will show (-) minus before the value.
8. Use the **M** button to view the frequency (Hz) of the measured current.

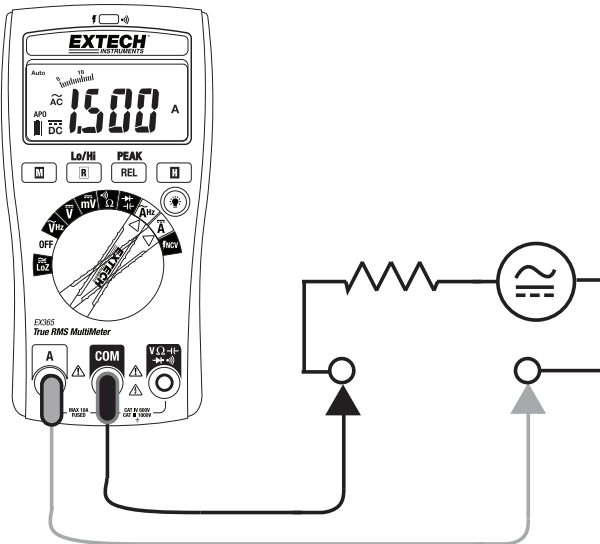

Fig 4-3 AC/DC 10A CURRENT MEASUREMENTS

μA AC/DC Current Measurements (EX363 only)



WARNING: Do not handle the test leads above the finger/hand guard barrier.



CAUTION: Observe CAT III 1000V and CAT IV 600V with respect to Earth Ground.

1. Insert the black test lead into the **COM** terminal and the red test lead into the **μA** terminal.
2. Turn the meter's function switch to the **μA** position. The **μA** units symbol will appear on the display indicating that micro-amperes are being measured.
3. The meter defaults to the Manual Range mode. Auto range cannot be used in this mode.
4. The meter display will show **AC** or **DC** depending on the function switch position.
5. Current measurements must be taken in series with the circuit under test. See accompanying diagram.
6. Touch the black test lead to the negative side of the circuit and the red test lead to the positive side of the circuit.
7. Read the current measurement in the display represented by the numerical digits and the bar graph. The display will indicate the proper decimal point and value. In DC, If the polarity is reversed, the display will show (-) minus before the value.

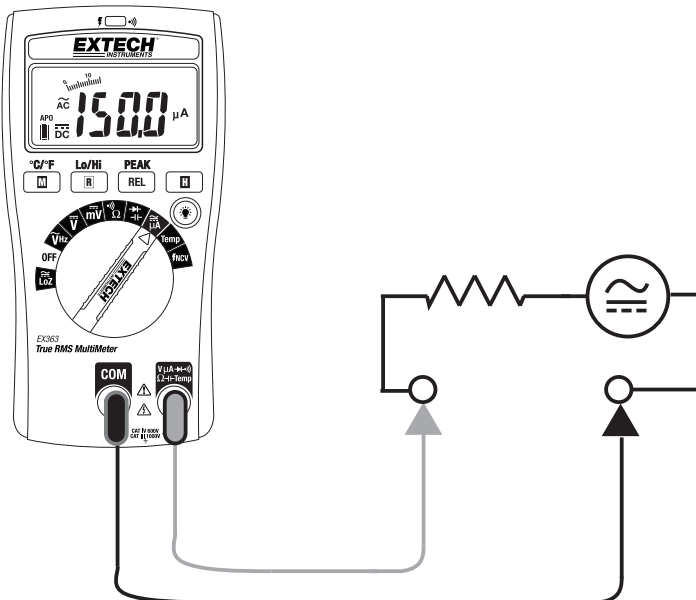

Fig 4-4 μA AC/DC CURRENT MEASUREMENTS

Non-Contact Voltage Detector



WARNING: It is possible for voltage to be present in a circuit even if the meter does not beep or light the NCV LED lamp at the top of the meter. Always verify meter operation on a known live AC current circuit and verify that the batteries are fresh before use.

The audible beeper sounds and the LED lamp at the top of the meter lights when the meter senses an electrical voltage field.

If the meter does not emit a tone or light the LED in this mode, there is still the possibility that voltage is present. Please use caution.

1. Turn the function switch to the **NCV** position to access the Non-Contact Voltage Detect mode.
2. Use the **Lo/Hi** button to select low sensitivity (160 to 1000V) or high sensitivity (80 to 1000V). The display will show **Lo** for low sensitivity or **Hi** for high sensitivity mode.
3. Note the voltage detection display icon  on the display when in this mode.
4. To test, place the meter near a source of electrical energy. Note that the tip of the meter offers the highest sensitivity.
5. Note the audible tone and the LED light when a source of electrical energy is detected.

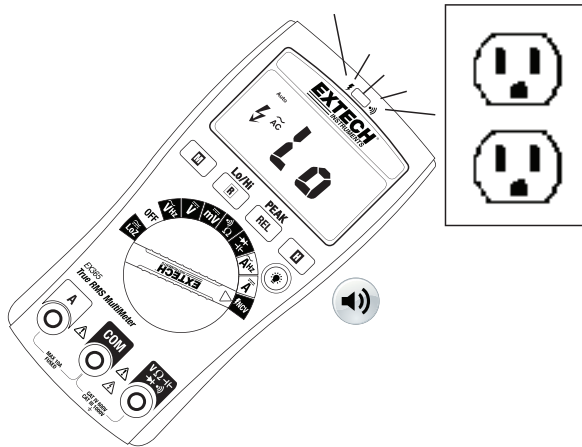

Fig 4-5 NON-CONTACT VOLTAGE DETECTOR

Resistance Measurements

Cautions: Switch OFF power to the device under test before measuring. Do not test on circuits or devices where 60VDC or 30VAC is present.

1. Insert the black test lead banana plug into the negative (COM) jack. Insert the red test lead banana plug into the positive (V/ Ω) jack.
2. Turn the Function Switch to the Ω position.
3. Use the **M** button to select the Ω icon on the display indicating resistance only (without the audible continuity icon showing).
4. Touch the test probe tips across the circuit or part under test. It is best to disconnect one side of the part under test so the rest of the circuit will not interfere with the resistance reading.
5. Read the resistance value in the display. The display will indicate the proper decimal point and value. If the reading is out of range, the **OL** display icon will appear.

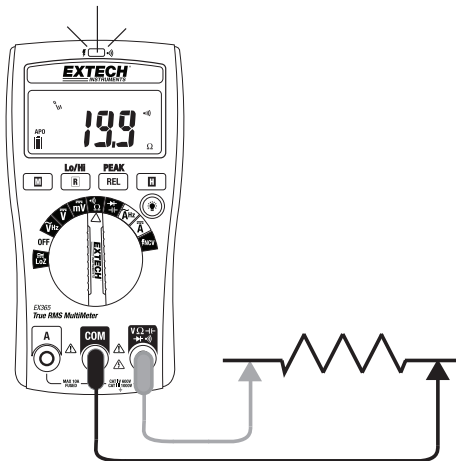

Fig 4-6 RESISTANCE/CONTINUITY MEASUREMENTS

Continuity Measurements

1. Insert the black test lead into the negative **COM** terminal and the red test lead into the positive terminal.
2. Set the function switch to the **)))** position.
3. Use the **M** button to select the Continuity mode. Look for the Continuity icon **)))** on the display.
4. Touch the test probe tips across the wire or circuit under test.
5. If the resistance is $< 20 \Omega$, the beeper will sound and the LED lamp at the top of the meter will flash. The beeper and LED lamp will switch off if the measured signal rises above approximately 200Ω . For an open circuit condition the meter will display **OL**.

Capacitance Measurements

WARNING: To avoid electric shock, remove power to the circuit under test and discharge the capacitor under test before measuring. Do not test on circuits or devices where 60VDC or 30VAC is present.

1. Set the function switch to the C capacitance position.
2. Insert the black test lead banana plug into the negative **COM** jack and the red test lead banana plug into the positive C jack.
3. Press the **M** button to select the unit of measure symbol **F**.
4. Touch the test probe tips across the part under test.
5. Use the Relative mode Δ to compare measurements to a saved, known capacitance value. See next section for Relative mode instructions.
6. Read the capacitance value in the display.
7. The display will indicate the proper decimal point and value.

Note: For large values of capacitance several seconds may be required before the reading stabilizes.

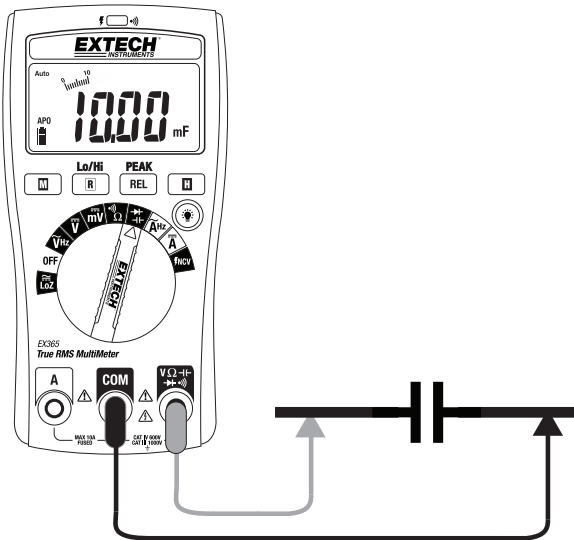

Fig 4-7 CAPACITANCE MEASUREMENTS

Relative Mode

In Relative mode a reference reading can be stored with which to compare subsequent readings. Press the Δ button to store the displayed reading in memory, this becomes the reference. The symbol Δ will be displayed when the Relative mode is active. Subsequent readings will now be compared to the stored reference (Displayed Reading = Measurement minus Reference). Press the Δ button again to exit the Relative mode; the Relative symbol will switch off.

Diode Test

1. Insert the black test lead banana plug into the negative **COM** jack and the red test lead banana plug into the **➔** positive jack.
2. Turn the function switch to **➔** position. Use the **M** button to select the diode function if necessary (the diode and voltage symbols will appear on the LCD when in Diode test mode).
3. Touch the test probe tips to the diode or semiconductor junction under test. Note the meter reading.
4. Reverse the test lead polarity by reversing the red and black leads. Note this reading.
5. The diode or junction can be evaluated as follows:
 - If one reading displays a value (typically 0.400V to 0.900V) and reverse reading displays **OL**, the diode is good.
 - If both readings display **OL** the device is open.
 - If both readings are very small or '0', the device is shorted.

Fig 4-8 DIODE TESTING

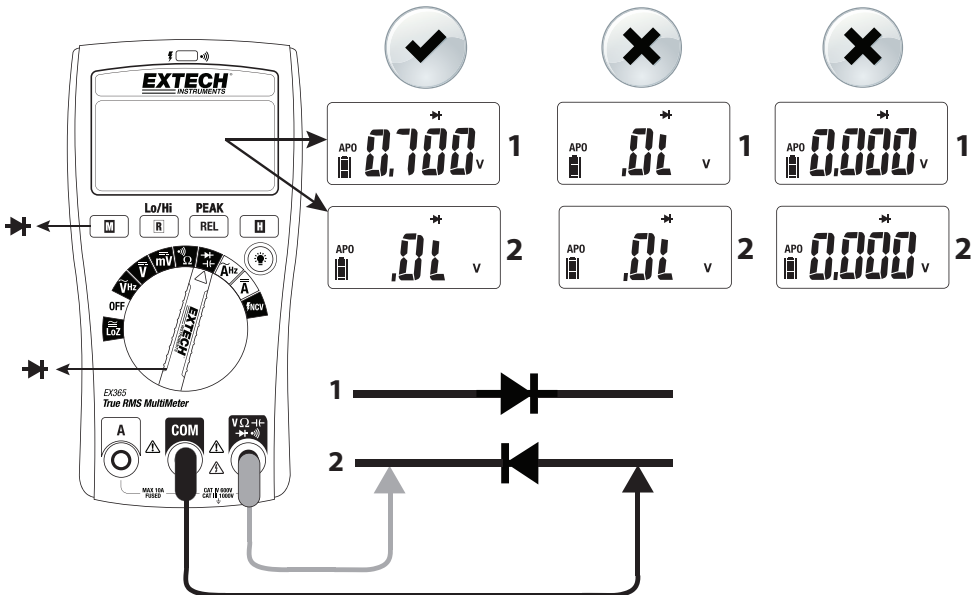

Temperature Measurements (EX363 only)

1. Insert the supplied temperature probe into the **COM** and positive terminals observing correct polarity.
2. Turn the function switch to the temperature position. Use the **°C/°F** button to select the desired unit of measure.
3. Touch the temperature probe tip to the device under test or leave the temperature probe in the open air to measure ambient temperature.
4. Read the temperature measurement on the LCD.
5. To set the currently selected unit of measure as default, press and hold the backlight button while turning the meter ON.

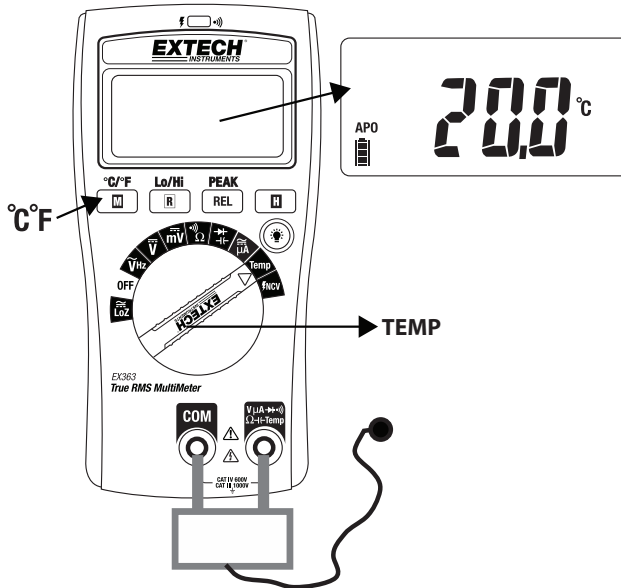

Fig 4-9 TEMPERATURE MEASUREMENTS

5. Maintenance



WARNING: To avoid electrical shock, remove the test leads, disconnect the meter from any circuit and turn OFF the meter before opening the case. Do not operate with an open case.

Battery Replacement

1. Remove the test leads from the meter.
2. Remove the meter's protective cover.
3. Remove the two Phillips head screws that secure the battery compartment at the back of the meter.
4. Open the battery compartment and replace the 9V battery observing correct polarity. Re-assemble the meter before use

Safety: Please dispose of batteries responsibly; never dispose of batteries in a fire, batteries may explode or leak. If the meter is not to be used for 60 days or more, remove the battery and store separately.

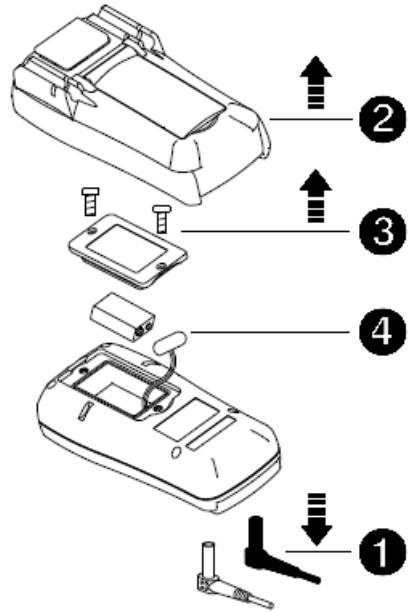

Fig 5-1 BATTERY REPLACEMENT



Never dispose of used batteries or rechargeable batteries in household waste. As consumers, users are legally required to take used batteries to appropriate collection sites, the retail store where the batteries were purchased, or wherever batteries are sold.

Disposal: Do not dispose of this instrument in household waste. The user is obligated to take end-of-life devices to a designated collection point for the disposal of electrical and electronic equipment.

Fuse Replacement



WARNING: To avoid electrical shock, remove the test leads, disconnect the meter from any circuit and turn OFF the meter before opening the case. Do not operate with an open case.

Follow the steps in the accompanying 11A/1000V fuse replacement diagram.

1. Remove the test leads from the meter.
2. Remove the meter's protective cover.
3. Remove the four (4) screws that secure the meter housing.
4. Replace the fuse with one of the same type and rating. Reassemble the meter before use.

Fig 5-2 FUSE REPLACEMENT

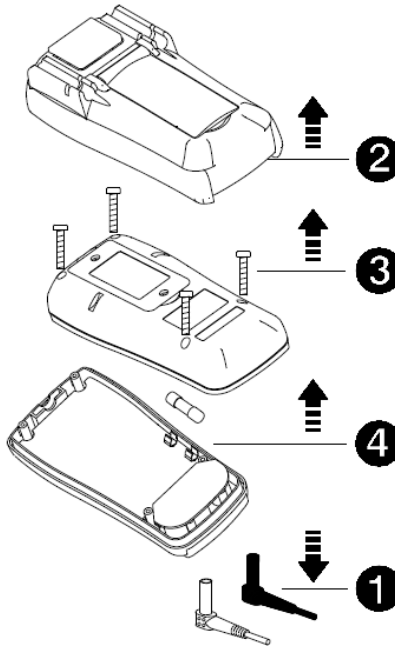

Cleaning and Storage

Periodically wipe the case with a damp cloth and mild detergent; do not use abrasives or solvents.

LCD Diagnostic Test

Press and hold the **H** button while turning the meter ON to view all LCD icons and symbols. Turn the meter OFF to end this diagnostic test. If there is reason to suspect that a display icon is not functioning, this is a handy verification. If the display is responding unusually, or if an icon is malfunctioning, please return the meter for service.

6. Specifications

ELECTRICAL SPECIFICATIONS

Accuracy is given as \pm (% of reading + least significant digit) at 23 °C \pm 5 °C with relative humidity lower than 80%. Accuracy is specified for a period of one year after calibration.

1. Temperature Coefficient is 0.1 x specified accuracy / °C, < 18 °C (64.5 °F), > 28 °C (82.4 °F)
2. AC Functionality: ACV and ACA specifications are AC coupled, True RMS; the accuracy for square waveforms is unspecified. For non-sinusoidal waveforms, additional accuracy Crest Factor (C.F.) considerations exist as detailed below:

Add 3.0% for C.F. 1.0~2.0; Add 5.0% for C.F. 2.0~2.5; Add 7.0% for C.F. 2.5~3.0

Function	Range	Resolution	Accuracy (of reading)	'OL' Reading
mV DC	600.0mV	0.1mV	\pm (0.5% + 5 digits)	660.0mV
<i>Input Impedance: 10M; Overload Protection: AC/DC 1000V</i>				
DC Voltage	6.000V	0.001V	\pm (0.5% + 2 digits)	6.600V
	60.00V	0.01V		66.00V
	600.0V	0.1V		660.0V
	1000V	1V		1100V
<i>Input Impedance: 10M; Overload Protection: AC/DC 1000V</i>				
AC Voltage	600.0mV	0.1mV	\pm (1.0% + 5 digits)	660.0mV
	6.000V	0.001V	\pm (1.0% + 3 digits)	6.600V
	60.00V	0.01V		66.00V
	600.0V	0.1V		660.0V
	1000V	1V		1100V
<i>LCD Displays '0' counts when the reading < 10 counts Input Impedance: 10MΩ (< 100pF) Frequency Response: 45~500Hz (sine wave) Over load protection: 1000V AC/DC</i>				
Lo Z (Low Impedance)	600.0V	0.1V	\pm (2.0% + 3 digits)	660.0V
	1000V	1V		1100V
<i>LCD Displays '0' counts when the reading < 10 counts Input Impedance: < 3kΩ Frequency Response: 45~500Hz (sine wave); Over load protection: 1000V AC/DC</i>				
μA DC (EX363 only)	600.0 μ A	0.1 μ A	\pm (1.0% + 2 digits)	660.0 μ A
<i>Input Impedance: 3k approx. Over load protection: 1000V AC/DC</i>				

Function	Range	Resolution	Accuracy (of reading)	'OL' Reading	
µA AC (EX363 only)	600.0 µA	0.1µA	± (1.5% + 3 digits)	660.0µA	
<i>LCD Displays '0' counts when the reading < 10 counts</i> <i>Input Impedance: 3kΩ approx.</i> <i>Frequency Response: 45~500Hz (sine wave)</i> <i>Over load protection: 1000V AC/DC</i>					
AC Current (EX365)	6.000 A	0.001	± (1.5% + 3 digits)	6.600A	
	10.00 A	0.01		20.00A	
<i>In 6A Range, the LCD displays 0 counts when the reading < 20 counts.</i> <i>In10A Range, the LCD displays 0 counts when the reading < 10 counts.</i> <i>Maximum measurement time: >5A for max. 3 minutes with at least 20 minutes rest time.</i> <i>>10A for max. 30 seconds with at least 10 minutes rest time.</i> <i>Frequency Response : 45 ~ 500Hz (Sine Wave)</i> <i>Overload Protection : AC/DC 11A</i>					
DC Current (EX365)	6.000 A	0.001	± (1.0% + 3 digits)	6.600A	
	10.00 A	0.01		20.00A	
<i>Maximum measurement time : >5A for max. 3 minutes with at least 20 minutes rest time.</i> <i>>10A for max. 30 seconds with at least 10 minutes rest time.</i> <i>Overload Protection : AC/DC 11A</i>					
Resistance	600.0 Ω	0.1 Ω	± (0.9% + 5 digits)	660.0 Ω	
	6.000k Ω	0.001k Ω	± (0.9% + 2 digits)	6.600 kΩ	
	60.00k Ω	0.01k Ω	± (0.9% + 2 digits)	66.00 kΩ	
	600.0k Ω	0.1k Ω	± (0.9% + 2 digits)	660.0 kΩ	
	6.000M Ω	0.001M Ω	± (0.9% + 2 digits)	6.600 MΩ	
	40.00M Ω	0.01M Ω	± (1.5% + 5 digits)	44.00 MΩ	
<i>Overload Protection: 1000V AC/DC</i> <i>Note that digits may fluctuate ±50 digits when measuring above 10.00M</i>					
Continuity	600.0 Ω	0.1 Ω	± (0.9% + 5 digits)	660.0 Ω	
<i>Continuity: Built-in beeper sounds when measured resistance is less than 20Ω. Beeper turns off when measured resistance goes above 200Ω</i> <i>Continuity beeper frequency tone: 2KHz; Response Time: < 500µsec.; Overload Protection: AC/DC 1000V</i>					
Diode	1.550V	0.001V	± (0.9% + 2 digits)	n/a	
<i>Open Circuit Voltage : Approx. 1.8V; Overload Protection : AC/DC 1000V</i>					
Capacitance	1.000 µF	0.001 µF	± (1.9% + 5 digits)	1.100 µF	
	10.00 µF	0.01 µF		± (1.9% + 2 digits)	11.00 µF
	100.0 µF	0.1 µF			110.0 µF
	1.000 mF	0.001 mF			1.100 mF
	10.00 mF	0.01 mF			11.00 mF
<i>Overload Protection: 1000V AC/DC</i>					

Function	Range	Resolution	Accuracy (of reading)	'OL' Reading
Frequency	100.00 Hz	0.01 Hz	± (0.1% + 2 digits)	100.00 Hz
	1000.0 Hz	0.1 Hz		1000.0 Hz
	10.000 kHz	0.001kHz		10.000 kHz
	100.00 kHz	0.01kHz		100.00 kHz
<i>Minimum Sensitivity: > 5V (for ACV 1Hz ~ 10kHz) > 20.0V (for ACV 10kHz ~ 50kHz) unspecified (for ACV 50kHz ~ 100kHz) >0.6A (for ACA) Minimum Frequency: 1Hz Overload Protection: AC/DC 1000V or 11A</i>				
Temp. (EX363)	-40.0~400.0 °C	0.1°	± (1.0% + 20 digits)*	440.0 °C
	-40.0~752.0 °F	0.1°	± (1.0% + 36 digits)*	824.0 °F
	<i>*Does not include accuracy of the temperature probe. Accuracy specifications assume surrounding temperature stable to ±1°C. For ambient temperature changes of ±2°C, rated accuracy applies after 2 hours of stabilization time. OVERLOAD PROTECTION: AC/DC 1000V</i>			
Peak MIN-MAX			Specified accuracy ± 150 digits	
<i>Accuracy of square wave is unspecified</i>				
Non-Contact Voltage Detector	80~1000V (high sensitivity mode) 50~60Hz			
	160~1000V (low sensitivity mode) 50~60Hz			
<i>The tip of the meter offers the optimum sensitivity</i>				

GENERAL SPECIFICATIONS

Display	6000-count Multi-Function LCD
Over-range indication	“OL” or “-OL” is displayed
Conversion rate	3 updates per second
Maximum Voltage	1000VAC RMS or 1000V DC maximum applied to any terminal
Polarity indication	Automatic: positive implied, negative indicated (-)
Low battery indication	 is displayed. Meter also displays available battery power at startup
Auto Power OFF	After 20 minutes (can be disabled by holding the M (MODE) button while turning the meter ON)

Operating Temperature and Humidity

-10~10°C (14~50°F)
10~30°C (50~86°F); 80%RH maximum
30~40°C (86~104°F); 75%RH maximum
40~50°C (104~122°F); 45%RH maximum

Storage Temperature and Humidity

-20~60°C (-4~140°F); 80%RH maximum (with battery removed)

Operating Altitude	2000m (6562')
Battery power	9V battery (battery life 200 hours typical with alkaline battery types)
Fuse protection	11A/1000V AC/DC high energy (IR 20kA) DMM-B-11A (EX365 only)
Weight	250g (8.8 oz.)Including battery
Dimensions (W x H x D)	74 x 156 x 44mm (2.9 x 6.1 x 1.7")
Safety Standards	Complies with EN61010-1, CAT IV 600V, CAT III 1000V, Pollution Degree 2
EMC	EN61326-1
Shock and Vibration	Sinusoidal vibration MIL-PRF-28800F (5~55 Hz, 3g max.)
Drop Protection	1.2m (4') drop onto hardwood on concrete flooring
For Indoor Use	

Copyright © 2015 FLIR Systems, Inc.

All rights reserved including the right of reproduction in whole or in part in any form
ISO-9001 Certified

www.extech.com